

CATALOGUE | CATALOGO

08 > 2013



H.P. WATER CLEANERS › VACUUM CLEANERS

IDROPULTRICI › ASPIRATORI

clean





COMPANY  
WITH QUALITY SYSTEM  
CERTIFIED BY DNV  
= ISO 9001/2008 =

## BLUE SERIES COMMERCIAL

X-STAR	6
KR 1100	8
KL	10
KSM	12
KS	14
KT	16
STATIC	18
ETM	20
KA	22

## BLUE SERIES PROFESSIONAL

K250	24
K COMPACT	26
K PREMIUM	28

## K STEEL

K 803 S › K 805 S › K 807 S › K 809 S	30
K 803 TS › K 805 TS › K 807 TS › K 809 TS › K 801 TS › K 901 TS	32
K 809 ECO › K 801 ECO › K 901 ECO	34
K 1001 TS › K 1251 TS › K 1501 TS	36
K XTREME	38
K 2000 › K 2500	40

## X-SPECIAL

FDX 2	42
FDX ELITE	44
FDX PRO	46
FDX 4	48
FDX XTREME	50
FDX HOT CUBE	52
FDX WB	54
PTO	56

## RED SERIES COMMERCIAL

TRAPPER 2	58
SCOUT	60
KD 2	62
KM BASIC	64

## RED SERIES PROFESSIONAL

KM CLASSIC	66
KM EXTRA	68
KE PREMIUM PLUS	70
KF CLASSIC	72
KF EXTRA	74

## VACUUM CLEANERS › ASPIRATORI

VACUUM CLEANERS › ASPIRATORI	76
------------------------------	----

## NEBULIZERS › NEBULIZZATORI

NEBULIZERS › NEBULIZZATORI	84
----------------------------	----

## DETERGENTS › DETERGENTI

DETERGENTS › DETERGENTI	86
-------------------------	----

## ACCESSORIES › ACCESSORI

BLUE SERIES COMMERCIAL	88
BLUE SERIES PROFESSIONAL	94
X-SPECIAL	104
RED SERIES COMMERCIAL	114
RED SERIES PROFESSIONAL	116
VACUUM CLEANERS ACCESSORIES › ACESSORI ASPIRATORI	122
NOZZLES › UGELLI	124

# LEGEND > LEGENDA



Cold water H.P. Cleaners - Idropultrici ad acqua fredda



Hot water H.P. Cleaners - Idropultrici ad acqua calda



V = Voltage - Tensione



bar - MPa = Max pressure - Pressione max



l/h = Max flow rate - Portata max



HP = Electric Motor power - Potenza motore elettrico



CV = Engine Motor power - Potenza motore a scoppio



CV = Engine Motor power - Potenza motore a scoppio



kW = Absorbed power - Potenza assorbita



°C = Outlet max water temperature - Temperatura max uscita acqua



lt = Diesel tank - Serbatoio gasolio



kg/h = Fuel consumption - Consumo combustibile



lt = Detergent tank - Serbatoio detergente



kg = Weight - Peso



cm = Dimensions - Dimensioni



RPM motor - Giri motore



RPM pump - Giri pompa

## TotalStop

Device that automatically stops the motor when the gun is closed.

*Dispositivo che consente lo spegnimento automatico del motore alla chiusura della pistola.*

## EASY-START

Device that guarantees starting of the motor under any and all connection conditions, even if there is a drop in mains voltage.

*Dispositivo che garantisce la partenza del motore in ogni condizione di allacciamento, anche in presenza di cali di tensione della rete elettrica.*

## PREMIUM



**EXCLUSIVE NO-OIL-LEAK SYSTEM**  
in the crankcase minimising wear of the piston oil seal (PATENTED)

**ESCLUSIVO SISTEMA DI TENUTA TRA CARTER E TESTATA**

*che impedisce l'ingresso di polvere e sporizia nella zona di scorrimento pistoni pur permettendo la fuoriuscita dell'acqua (BREVETTATO)*



**EXCLUSIVE PACKING SYSTEM**  
New self lubricating double packing design with special bunatexile seals and bronze rings for an exceptional packing life.

**ESCLUSIVO SISTEMA DI TENUTE ACQUA AUTOLUBRIFICATO** con doppio pacco di guarnizioni in gomma tela rinforzate con anelli in teflon/bronzo per una eccezionale durata delle guarnizioni



**EXCLUSIVE SEALING SYSTEM BETWEEN CRANKCASE AND PUMP HEAD** that prevents dust and dirt getting inside where the pistons work but letting water out (PATENTED)

**ESCLUSIVO SISTEMA DI TENUTA OLIO** nel carter che minimizza l'usura del paraolio pistoni (BREVETTATO)

# BA10 BACKFLOW PREVENTER



**BA 10** › BackFlow Preventer is a special safety device that prevents water flowing back to the source, isolating the drinking water supply network from the circuit that supplies water to the cleaner.

**BA 10** › BackFlow Preventer è uno speciale dispositivo di sicurezza che evita il riflusso d'acqua verso la fonte, isolando la rete idrica potabile dal circuito di alimentazione dell'idropulitrice.



## MANDATORY BY LAW EN 60335 - 2 - 79 : 2010

According to the EU directives currently in force, the water that passes through a high-pressure cleaner is no longer considered fit for drinking. This is why it cannot be connected directly to the drinking water supply network unless a BA 10 Back Flow Preventer disconnecter has been installed.

## OBBLIGATORIO PER LEGGE EN 60335 - 2 - 79 : 2010

Secondo le vigenti direttive comunitarie, l'acqua che attraversa un'idropulitrice non è più considerata potabile. Per tale motivo un'idropulitrice non può essere collegata direttamente alla rete d'acqua potabile senza aver prima installato il disconnettore BA 10 Back Flow Preventer.



The BA10 › BackFlow Preventer is easily fitted directly on the water tap.

**BA10** › BackFlow Preventer si monta con estrema semplicità direttamente al rubinetto della rete idrica.



When the tap is turned on the flow of water hermetically closes the BA10 › BackFlow Preventer discharge valve that acts just like part of a straight hose.

All'apertura del rubinetto, il flusso d'acqua chiude ermeticamente la valvola di scarico del BA10 › BackFlow Preventer che si comporta come una porzione di tubo rettilineo.



The BA10 › BackFlow Preventer starts working when network pressure drops, cutting the drinking water supply network off from the circuit supplying the high-pressure cleaner, discharging the water externally.

**BA10** › BackFlow Preventer entra in funzione quando la pressione di rete cala, isolando la rete idrica potabile dal circuito di alimentazione dell'idropulitrice, scaricando all'esterno l'acqua.



Horizontal fitting  
Installazione orizzontale



Vertical fitting  
Installazione verticale



Do not connect it directly to the high-pressure cleaner  
Non collegare direttamente all'idropulitrice



# X-STAR



## GENERAL FEATURES

- Vertical structure, designed for maximum ergonomics and ease of use
- Comet electrical pump with pump at the bottom and an all-metal construction without any plastic used for the structural components
- **EASY-START** device
- **TotalStop** device
- Motor thermal cut-out



## CARATTERISTICHE GENERALI

- *Struttura a sviluppo verticale concepita per la massima ergonomia e praticità d'uso*
- *Elettropompa Comet con pompa in basso e costruzione interamente in metallo, senza materiale plastico nei componenti strutturali*
- Dispositivo **EASY-START**
- Dispositivo **TotalStop**
- Protezione termica del motore
- Uso domestico

- Practical handle for easy handling
- Comoda maniglia per facilitare la movimentazione



- Quickfit coupling for connecting to the water mains
- Raccordo con attacco rapido per il collegamento alla rete idrica



CODE CODICE	MODELS MODELLI									
		Ph	V	Hz	bar	MPa	l/h	kW	kg	(L x W x H) cm
9048 0001	X-STAR Classic	1	230	50	120	12,0	360	1,6	11	44 x 21 x 21
9048 0501	X-STAR Extra	1	230	50	120	12,0	360	1,6	11	44 x 21 x 21



STANDARD ACCESSORIES › DOTAZIONE STANDARD

CLASSIC	EXTRA
	Gun with protection <i>Kit pistola con protezione</i>
	Lance without nozzle head (securfix) <i>Lancia senza testina ugello (securfix)</i>
	Adjustable nozzle head (securfix) <i>Testina ugello regolabile (securfix)</i>
	 Rotating nozzle head (securfix) <i>Testina ugello rotante (securfix)</i>
	Foam lance <i>Lancia schiumogena</i>
	6 m delivery hose kit <i>Kit tubo mandata 6 m</i>
	 Fixed brush <i>Idrospazzola fissa</i>



# KR 1100



## GENERAL FEATURES

- Easy handling thanks to the 115 mm diameter wheels
- Quick water intake fitting
- **Vertical electrical pump with pump at the bottom and an all-metal construction without any plastic used for the structural components.**
- **TotalStop** device
- Universal type motor
- Motor thermal cut-out

## CARATTERISTICHE GENERALI

- *Facilità di movimento grazie alle ruote di diametro 115 mm*
- *Attacco rapido aspirazione acqua*
- **Elettropompa disposta in verticale con pompa in basso, costruzione interamente in metallo, senza materiale plastico nei componenti strutturali**
- **Dispositivo TotalStop**
- *Motore di tipo universale*
- *Protezione termica del motore*
- *Uso domestico*



- Practical positioning of the power cable and delivery hose.
- *Pratico posizionamento cavo elettrico e tubo di mandata.*

- Ergonomic handle for easy handling
- *Comoda maniglia di presa ergonomica per facilitare la movimentazione dell'idropultrice*

- Easy-to-fit accessories
- *Pratici alloggiamenti per gli accessori*



CODE CODICE	MODEL MODELLO									
		Ph	V	Hz	bar	MPa	l/h	kW	kg	(L x W x H) cm
9054 0001	KR 1100	1	230	50	120	12,0	360	1,6	10	82 x 28 x 26



**STANDARD ACCESSORIES › DOTAZIONE STANDARD**

	Gun kit with protection <i>Pistola con protezione</i>
	Lance with adjustable nozzle <i>Lancia con ugello regolabile</i>
	Lance with rotating nozzle <i>Lancia con ugello rotante</i>
	Foam lance <i>Lancia schiumogena</i>
	5 m delivery hose kit <i>Kit tubo mandata 5 m</i>
	Suction coupler <i>Raccordo aspirazione</i>
	Water filter <i>Filtro acqua</i>



# KL



## 1300 - 1400 - 1600



### GENERAL FEATURES

- Vertical structure, designed for maximum ergonomics and ease of use
- Comet electrical pump with three axial pistons arranged vertically with pump at the bottom and an all-metal construction without any plastic used for the structural components.
- Brass pump head for KL 1600 Gold only
- **EASY-START** device
- **TotalStop** device
- Motor thermal cut-out
- Quick water intake fitting



### CARATTERISTICHE GENERALI

- *Struttura a sviluppo verticale concepita per la massima ergonomia e praticità d'uso*
- *Elettropompa Comet a tre pistoni assiali disposta in verticale con pompa in basso e costruzione interamente in metallo, senza materiale plastico nei componenti strutturali.*
- *Testata pompa in ottone per KL 1600 Gold*
- Dispositivo **EASY-START**
- Dispositivo **TotalStop**
- Protezione termica del motore
- Attacco rapido aspirazione acqua
- *Uso domestico*

- Easy-to-fit accessories
- Pratici alloggiamenti per gli accessori

- Hose reel at the back
- Avvolgitubo collocato nella parte posteriore

- Easy to handle thanks to the big wheels (*rubber coated on the KL 1600 Gold model*)
- Facilità di movimento grazie alle ruote di grandi dimensioni (*rivestite in gomma nel modello KL 1600 Gold*)

- Additional handle for lifting
- Maniglia supplementare per il sollevamento



CODE CODICE	MODELS MODELLI									
		Ph	V	Hz	bar	MPa	l/h	kW	kg	(L x W x H) cm
9046 0066	KL Classic 1300	1	230	50	130	13,0	360	1,7	12	82 x 30,8 x 31
9046 0003	KL Classic 1400	1	230	50	140	14,0	410	2,0	12	82 x 30,8 x 31
9046 0065	KL Classic 1600	1	230	50	150	15,0	480	2,3	12	82 x 30,8 x 31
9046 0067	KL Extra 1300	1	230	50	130	13,0	360	1,7	13	82 x 30,8 x 31
9046 0004	KL Extra 1400	1	230	50	140	14,0	410	2,0	13	82 x 30,8 x 31
9046 0064	KL Extra 1600	1	230	50	150	15,0	480	2,3	13	82 x 30,8 x 31



STANDARD ACCESSORIES › DOTAZIONE STANDARD

CLASSIC	EXTRA
	Gun with protection <i>Pistola con protezione</i>
	Lance without nozzle head (securfix) <i>Lancia senza testina ugello (securfix)</i>
	Adjustable nozzle head (securfix) <i>Testina ugello regolabile (securfix)</i>
	Rotating nozzle head (securfix) <i>Testina ugello rotante (securfix)</i>
	Foam lance <i>Lancia schiumogena</i>
6 m delivery hose kit <i>Kit tubo mandata 6 m</i>	8 m delivery hose kit <i>Kit tubo mandata 8 m</i>
	Fixed brush <i>Idrospazzola fissa</i>



# KSM



## 1450 - 1480 GOLD



### GENERAL FEATURES

- Comet electrical pump with three axial pistons arranged vertically with pump at the bottom and an all-metal construction without any plastic used for the structural components.
- KSM 1480 Gold equipped with a brass pump head
- **EASY-START** device
- **TotalStop** device
- Motor thermal cut-out
- Quick water intake fitting
- Supports for housing the accessories and power cable



### CARATTERISTICHE GENERALI

- *Elettropompa Comet a tre pistoni assiali disposta in verticale con pompa in basso e costruzione interamente in metallo, senza materiale plastico nei componenti strutturali.*
- *KSM 1480 Gold dotata di testata pompa in ottone*
- Dispositivo **EASY-START**
- Dispositivo **TotalStop**
- Protezione termica del motore
- Attacco rapido aspirazione acqua
- Supporti per l'alloggiamento degli accessori e del cavo di alimentazione
- Uso semiprofessionale

- Ergonomic handle for easy handling
- Comoda maniglia di presa per facilitare la movimentazione dell'idropultrice



- Easy to handle up and down steps thanks to the big wheels
- Facilità di movimento su gradini grazie alle ruote di grandi dimensioni



- Hose reel with 10 m high-pressure hose (for Extra models only)
- Avvolgitubo con tubo alta pressione 10 m (solo per modelli Extra)



CODE CODICE	MODELS MODELLI									
		Ph	V	Hz	bar	MPa	l/h	kW	kg	(L x W x H) cm
9043 0001	KSM Classic 1450	1	230	50	145	14,5	480	2,3	17	89 x 32 x 38
9043 0052	KSM Gold Classic 1480	1	230	50	150	15,0	480	2,3	17	89 x 32 x 38
9043 0002	KSM Extra 1450	1	230	50	145	14,5	480	2,3	19	89 x 32 x 38
9043 0062	KSM Gold Extra 1480	1	230	50	150	15,0	480	2,3	19	89 x 32 x 38



STANDARD ACCESSORIES › DOTAZIONE STANDARD

CLASSIC		EXTRA	
	Gun with protection <i>Pistola con protezione</i>		Lance with adjustable nozzle <i>Tubo lancia con ugello regolabile</i>
	Foam lance <i>Lancia schiumogena</i>		Lance with rotating nozzle <i>Lancia con ugello rotante</i>
	7 m delivery hose kit <i>Kit tubo mandata 7 m</i>		10 m delivery hose kit <i>Kit tubo mandata 10 m</i>

## BLUE SERIES COMMERCIAL



# KS



## 1600 - 1700



### GENERAL FEATURES

- Comet electrical pump with three axial pistons arranged vertically with pump at the bottom and an all-metal construction without any plastic used for the structural components.
- KS 1700 equipped with a brass pump head and detergent suction straight from a 1.8 litre capacity tank
- **EASY-START** device
- **TotalStop** device
- Manually resettable amperometric protection
- Pressure gauge
- Quick water intake fitting



### CARATTERISTICHE GENERALI

- *Elettropompa Comet a tre pistoni assiali disposta in verticale con pompa in basso e costruzione interamente in metallo, senza materiale plastico nei componenti strutturali.*
- *KS 1700 dotata di testata pompa in ottone e aspirazione del detergente diretta da serbatoio capacità 1,8 lt*
- Dispositivo **EASY-START**
- Dispositivo **TotalStop**
- Protettore amperometrico a riarmo manuale
- Manometro pressione
- Attacco rapido aspirazione acqua
- Uso semiprofessionale

- Ergonomic handle for easy handling
- Comoda maniglia di presa per facilitare la movimentazione dell'idropulitrice



- Easy to handle up and down steps thanks to the big wheels
- Facilità di movimento su gradini grazie alle ruote di grandi dimensioni



- Hose reel with 10 m high-pressure hose (for Extra models only)
- Avvolgitubo con tubo alta pressione 10 m (solo per modelli Extra)



CODE CODICE	MODELS MODELLI										
		Ph	V	Hz	bar	MPa	l/h	kW	l	kg	(L x W x H) cm
9041 0001	KS Classic 1600	1	230	50	145	14,5	510	2,4	-	17	89 x 32 x 38
9041 0002	KS Classic 1700	1	230	50	155	15,5	540	2,7	1,8	17	89 x 32 x 38
9041 0501	KS Extra 1600	1	230	50	145	14,5	510	2,4	-	19	89 x 32 x 38
9041 0502	KS Extra 1700	1	230	50	155	15,5	540	2,7	1,8	19	89 x 32 x 38



STANDARD ACCESSORIES › DOTAZIONE STANDARD

CLASSIC		EXTRA	
	Gun GC 251 Pistola GC 251		Bent lance, with adjustable nozzle Lancia angolata, con ugello regolabile
	Nozzle, for possible parts replacement Ugello per lancia, per eventuale ricambio		Bent lance, with rotating nozzle Lancia angolata, con ugello rotante
	8 m delivery hose kit Kit tubo mandata 8 m		10 m delivery hose kit Kit tubo mandata 10 m
	Foam lance (for KS1600 models only) Lancia schiumogena (solo per modelli KS 1600)		



# KT



## 1750 - 1800 - 1900



### GENERAL FEATURES

- **Hose reel (Extra only)** located at the bottom of the high-pressure water cleaner guaranteeing exceptional stability also when in use.
- Low-pressure detergent suction from the internal tank
- Suction kit from an external tank
- Rear power cable storage compartment
- **Comet electrical pump with three axial pistons arranged vertically with pump at the bottom and an all-metal construction without any plastic used for the structural components.**
- **Pump with brass head**
- **EASY-START** device
- **TotalStop** device
- Motor thermal cut-out



### CARATTERISTICHE GENERALI

- **Avvolgitubo (solo Extra)** collocato nella parte inferiore della idropulitrice con garanzia di eccezionale stabilità della macchina anche durante il lavoro.
- Aspirazione detergente in bassa pressione dal serbatoio interno
- Kit aspirazione da serbatoio esterno
- Vano posteriore per collocare il cavo elettrico
- **Elettropompa Comet a tre pistoni assiali disposta in verticale con pompa in basso e costruzione interamente in metallo, senza materiale plastico nei componenti strutturali.**
- **Pompa con testata in ottone**
- Dispositivo **EASY-START**
- Dispositivo **TotalStop**
- Protezione termica motore
- **Uso semiprofessionale**



- Easy handling thanks to the two big wheels (250 mm Ø)
- *Facilità di movimentazione grazie alle due ruote di grandi dimensioni (Ø 250 mm)*

- Handy lance and gun storage
- *Pratico alloggiamento della pistola della lancia*

- Hose reel  
**(Extra models only)**
- *Avvolgitubo (solo modelli Extra)*

- Additional handle for lifting the high-pressure cleaner
- *Maniglia supplementare per il sollevamento dell'idropulitrice*



CODE CODICE	MODELS MODELLI										
		Ph	V	Hz	bar	MPa	l/h	kW	l	kg	(L x W x H) cm
9053 0005	KT 1750 Classic	1	230	50	150	15,0	510	2,4	1	22	40 x 41 x 91
9053 0001	KT 1800 Classic	1	230	50	160	16,0	550	2,7	1	22	40 x 41 x 91
9053 0003	KT 1900 Classic	1	230	50	160	16,0	600	2,9	1	22	40 x 41 x 91
9053 0006	KT 1750 Extra	1	230	50	150	15,0	510	2,4	1	25	40 x 41 x 91
9053 0002	KT 1800 Extra	1	230	50	160	16,0	550	2,7	1	25	40 x 41 x 91
9053 0004	KT 1900 Extra	1	230	50	160	16,0	600	2,9	1	25	40 x 41 x 91



**STANDARD ACCESSORIES › DOTAZIONE STANDARD**

CLASSIC	EXTRA
	Gun GC 251 <i>Pistola GC 251</i>
	Bent lance, with adjustable nozzle <i>Kit tubo lancia angolata, con ugello regolabile</i>
	Nozzle, for possible parts replacement <i>Ugello per lancia, per eventuale ricambio</i>
	 Bent lance, with rotating nozzle <i>Lancia angolata, con ugello rotante</i>
	 Fixed brush <i>Idrospazzola fissa</i>
 8 m delivery hose kit <i>Kit tubo mandata 8 m</i>	 12 m delivery hose kit <i>Kit tubo mandata 12 m</i>



# STATIC



## 1700 - 1900



### GENERAL FEATURES

- Sturdy structure with tubular frame for wall mounting
- Equipped with a quick wall coupling system with safety lock
- Handy support for housing all the accessories
- Standard hose reel with rubber delivery hose
- Water inlet with cartridge filter
- **Comet electrical pump with three axial pistons arranged horizontally with pump at the bottom and an all-metal construction without any plastic used for the structural components.**
- **Pump with brass head**
- **EASY-START** device
- **TotalStop** device
- Motor thermal cut-out



### CARATTERISTICHE GENERALI

- *Robusta struttura per applicazione a parete con telaio tubolare*
- *Equipaggiata con sistema di aggancio rapido a muro, con blocco di sicurezza*
- *Pratico supporto per alloggiare tutti gli accessori*
- *Avvolgitubo di serie con tubo mandata in gomma*
- *Ingresso acqua con filtro a cartuccia*
- ***Elettropompa Comet a tre pistoni assiali disposta in orizzontale con pompa in basso e costruzione interamente in metallo, senza materiale plastico nei componenti strutturali.***
- ***Pompa con testata in ottone***
- ***Dispositivo EASY-START***
- ***Dispositivo TotalStop***
- ***Protezione Termica del motore***
- ***Uso semiprofessionale***

## DUAL USE › DOPPIO USO

- Permanently fixed on the wall – always ready to use
- Fissaggio statico a parete sempre pronta all'uso

- Easily removed
- Facilmente removibile

- Easy to move to wherever else wanted
- Facilmente trasportabile in altri posti di utilizzo



CODE CODICE	MODELS MODELLI									
		Ph	V	Hz	bar	MPa	l/h	kW	kg	(L x W x H) cm
9052 0001	STATIC 1700 Classic	1	230	50	150	15,0	510	2,4	20	50 x 26 x 60
9052 0008	STATIC 1900 Classic	1	230	50	160	16,0	600	2,9	21	50 x 26 x 60
9052 0002	STATIC 1700 Extra	1	230	50	150	15,0	510	2,4	22	50 x 26 x 60
9052 0015	STATIC 1700 Extra with blue food- industry hose con tubo blu anti-macchia	1	230	50	150	15,0	510	2,4	22	50 x 26 x 60
9052 0009	STATIC 1900 Extra	1	230	50	160	16,0	600	2,9	23	50 x 26 x 60

- Brass pump head that withstands pressure and is corrosion resistant
- Pompa con testata in ottone resistente alla pressione ed alla corrosione

- Hose reel with 10 or 20 meter high pressure hose
- Avvolgitubo con 10 o 20 metri di tubo ad alta pressione

- Hose cleaning guide kit (optional)
- Kit guida - pulisci tubo (optional)

- Accessory rack supplied with the high-pressure cleaner
- Supporto per gli accessori in dotazione all'idropulitrice



## STANDARD ACCESSORIES › DOTAZIONE STANDARD

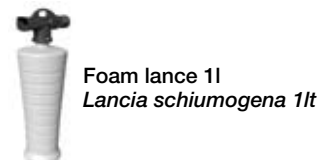



# ETM



## GENERAL FEATURES

- Compact
- Easy to transport thanks to a practical top grip and anti-vibration supports
- 2-pole motor (2800 rpm) for continuous use
- **Comet AXR-GXR pump, 3 pistons and brass pump head**
- Integrated professional pressure unloader valve
- **EASY-START** device
- **TotalStop** device
- Rotary switch
- Motor thermal cut-out



## CARATTERISTICHE GENERALI

- *Ingombro ridotto*
- *Semplicità di trasporto mediante confortevole impugnatura superiore ed appoggio su supporti antivibranti*
- *Motore a 2 poli (2800 giri/min) per uso continuo*
- **Pompa Comet AXR-GXR, 3 pistoni e testata in ottone**
- *Valvola di regolazione pressione professionale integrata*
- **Dispositivo EASY-START**
- **Dispositivo TotalStop**
- *Interruttore rotativo*
- *Protezione termica del motore*
- *Uso semiprofessionale*

- GXR Comet pump on ETM 100 model
- Pompa Comet GXR su modello ETM 100



- Pressure regulating knob with anti-tampering device
- Manopola regolazione pressione con dispositivo antimanomissione



- Delivery fitting with brass quick coupling
- Attacco di mandata con innesto rapido in ottone



- PRIMING device for taking up water also from external tanks (ETM 130 only)
- Dispositivo PRIMING che permette di aspirare acqua, anche da serbatoi esterni (solo ETM 130)



CODE CODICE	MODELS MODELLI									
		Ph	V	Hz	bar	MPa	l/h	kW	kg	(L x W x H) cm
9055 0004	ETM 100	1	230	50	130	13,0	480	2,3	23	26 x 47 x 37
9055 0001	ETM 130	1	230	50	130	13,0	720	2,9	27	26 x 47 x 37



**STANDARD ACCESSORIES › DOTAZIONE STANDARD**

	Gun GC 250 with Swivel <i>Pistola GC 250 con Swivel</i>
	Bent lance with detergent head, without nozzle <i>Lancia angolata con testina detergente, senza ugello</i>
	Fan shape nozzle 15°, 1/4" MEG connection <i>Ugello con getto a lama 15° attacco 1/4" MEG</i>
	8 m Rubber delivery hose kit with quick coupling <i>Kit tubo mandata 8 m con attacco rapido</i>



# KA



## 2800-3000-3200-4000-5000



### GENERAL FEATURES

- Compact size for storing and practical to use thanks to its vertical design
- Simple to transport horizontally in the car
- **Comet AXR pump (only KA 2800, GXR pump) with brass head**
- Pressure gauge
- Integrated professional pressure unloader valve
- **EASY-START** device on single-phase models
- **TotalStop** device
- Rotary switch
- Regulated low-pressure detergent suction
- Motor thermal cut-out



### CARATTERISTICHE GENERALI

- *Ingombro ridotto nella messa a riposo e praticità d'uso in condizioni di lavoro grazie allo sviluppo verticale*
- *Semplicità di trasporto su auto in posizione orizzontale*
- **Pompa Comet AXR (solo per KA 2800, pompa GXR) con testata in ottone**
- **Manometro pressione**
- **Valvola di regolazione pressione professionale integrata**
- **Dispositivo EASY-START sui modelli monofase**
- **Dispositivo TotalStop**
- **Interruttore rotativo**
- **Aspirazione detergente in bassa pressione con regolazione**
- **Protezione termica del motore**
- **Uso semiprofessionale gravoso**

- Adjustable detergent suction device from an external tank with filter
- *Dispositivo di aspirazione detergente da tanica esterna, regolabile con filtro*



- 4 l detergent tank, easily removed
- *Serbatoio detergente 4 lt facilmente rimovibile*



- Comet AXR pump, 3 axial plungers and brass pump head
- *Pompa Comet AXR, 3 pistoni assiali e testata in ottone*



- 15 m hose reel. Practical handle and stop device
- *Avvolgitubo di 15 m. Comoda maniglia e dispositivo di fermo*



CODE CODICE	MODELS MODELLI											
		Ph	V	Hz	bar	MPa	l/h	CV	kW	l	kg	(L x W x H) cm
9037 0147	KA Classic 2800M	1	230	50	140	14,0	540	2,6	2,6	4,0	36	44 x 42 x 94
9037 0002	KA Classic 3000 M	1	230	50	130	13,0	720	3,0	2,9	4,0	36	44 x 42 x 94
9037 0001	KA Classic 3200 M	1	230	50	150	15,0	600	3,0	2,9	4,0	36	44 x 42 x 94
9037 0005	KA Classic 5000 T	3	400	50	200	20,0	720	5,0	4,3	4,0	36	44 x 42 x 94
9037 0148	KA Excel 2800M	1	230	50	140	14,0	540	2,6	2,6	4,0	36	44 x 42 x 94
9037 0021	KA Excel 3000 M	1	230	50	130	13,0	720	3,0	2,9	4,0	36	44 x 42 x 94
9037 0012	KA Excel 3200 M	1	230	50	150	15,0	600	3,0	2,9	4,0	36	44 x 42 x 94
9037 0016	KA Excel 4000 T	3	400	50	170	17,0	720	4,3	3,8	4,0	36	44 x 42 x 94
9037 0019	KA Excel 5000 T	3	400	50	200	20,0	720	5,0	4,3	4,0	36	44 x 42 x 94



STANDARD ACCESSORIES > DOTAZIONE STANDARD

CLASSIC	EXCEL
	Gun GC 251 with protection <i>Pistola GC 251 con protezione</i>
	Lance with adjustable jet, with nozzle (for the KA 2800 model only) <i>Lancia getto regolabile con ugello (solo per modello KA 2800)</i>
	Nozzle, for possible parts replacement (for the KA 2800 model only) <i>Ugello per lancia, per eventuale ricambio (solo per modello KA 2800)</i>
	Bent lance with detergent head, without nozzle <i>Lancia angolata con testina detergente, senza ugello</i>
	Fan shape nozzle 15°, 1/4" MEG connection <i>Ugello con getto a lama 15° attacco 1/4" MEG</i>
	15 m rubber delivery hose kit <i>Kit tubo mandata 15 m</i>



# K 250



**1** CAN BE USED VERTICALLY  
UTILIZZABILE IN VERTICALE

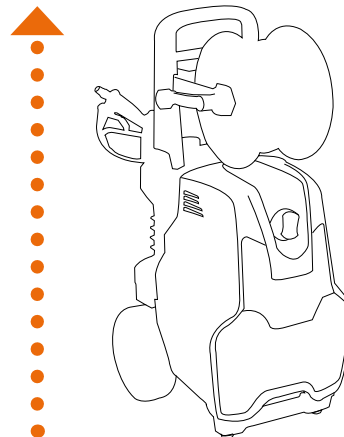

**2** CAN BE USED HORIZONTALLY  
UTILIZZABILE IN ORIZZONTALE

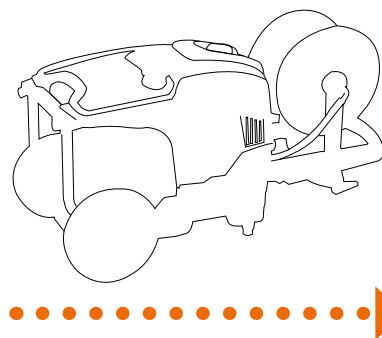

## GENERAL FEATURES

- Sturdy injection-moulded plastic casing
- Handy lance and gun storage
- Handle with supports for the power cable and delivery hose
- **Easy maintenance by simply removing the front casing**
- Big wheels (220 mm Ø) for easy movement up and down steps and over uneven ground
- Removable detergent tank with level that can be seen externally
- Detergent adjustment with filter
- Regulated low-pressure detergent suction
- Pressure gauge
- 4-pole motor (1400 rpm) well oversized and protected with paint
- Integrated professional pressure unloader valve
- **TotalStop**
- Self-priming pumps with **EASY-START** device on single-phase models
- Rotary switch
- Motor thermal cut-out

## CARATTERISTICHE GENERALI

- **Robuste carenature in materiale plastico stampato ad iniezione**
- **Pratico alloggiamento della pistola e della lancia**
- **Manico con supporti di cavo alimentazione e tubo mandata**
- **Facilità di manutenzione con la semplice rimozione della carenatura frontale**
- **Ruote di grandi dimensioni (Ø220mm) per una facile movimentazione su gradini e terreni accidentati**
- **Serbatoio detergente estraibile con livello visibile esternamente**
- **Regolazione detergente con filtro**
- **Aspirazione detergente in bassa pressione con regolazione**
- **Manometro di pressione**
- **Motore a 4 poli (1400 giri/min) ampiamente sovradimensionato e protetto da verniciatura**
- **Valvola di regolazione pressione professionale integrata**
- **TotalStop**
- **Pompe autoadescanti dispositivo EASY-START modelli monof.**
- **Interruttore rotativo**
- **Protezione termica motore**
- **Uso professionale**



- COMET LW-K type pump with 3 integral ceramic pistons. Oil sight glass. Brass pump heads.
- Pompa COMET tipo LW-K 3 pistoni in ceramica integrale. Visore livello olio Testate in ottone.



- Removable detergent tank with externally visible level
- Serbatoio detergente estraibile con livello visibile esternamente



● **K250 Classic**



- Hose reel 15/20 m (for Extra models only)
- Avvolgitubo 15/20 m (solo per modelli Extra)



CODE CODICE	MODELS MODELLI											
		Ph	V	Hz	bar	MPa	l/h	CV	kW	l	kg	(L x W x H) cm
9057 0002	K 250 10/150 M Classic	1	230	50	150	15,0	600	3,0	2,9	3,5	40	54 x 44 x 68
9057 0004	K 250 12/130 M Classic	1	230	50	130	13,0	720	3,0	2,9	3,5	40	54 x 44 x 68
9057 0006	K 250 11/160 M Classic *	1	230	50	160	16,0	660	3,5	3,3	3,5	40	54 x 44 x 68
9057 0008	K 250 13/190 T Classic	3	400	50	190	19,0	780	5,5	5,0	3,5	40	54 x 44 x 68
9057 0010	K 250 15/170 T Classic	3	400	50	170	17,0	900	5,5	5,0	3,5	40	54 x 44 x 68
9057 0012	K 250 11/210 T Classic	3	400	50	210	21,0	660	5,5	5,0	3,5	40	54 x 44 x 68
9057 0001	K 250 10/150 M Extra	1	230	50	150	15,0	600	3,0	2,9	3,5	50	54 x 44 x 99
9057 0003	K 250 12/130 M Extra	1	230	50	130	13,0	720	3,0	2,9	3,5	50	54 x 44 x 99
9057 0005	K 250 11/160 M Extra *	1	230	50	160	16,0	660	3,5	3,3	3,5	50	54 x 44 x 99
9057 0007	K 250 13/190 T Extra	3	400	50	190	19,0	780	5,5	5,0	3,5	50	54 x 44 x 99
9057 0009	K 250 15/170 T Extra	3	400	50	170	17,0	900	5,5	5,0	3,5	50	54 x 44 x 99
9057 0011	K 250 11/210 T Extra	3	400	50	210	21,0	660	5,5	5,0	3,5	50	54 x 44 x 99

\* requires 4 kW electricity supply - richiede rete elettrica da 4 kW



**STANDARD ACCESSORIES › DOTAZIONE STANDARD**

CLASSIC		EXTRA	
	Gun GC 251 with protection <i>Pistola GC 251 con protezione</i>		Gun GH 301 with swivel <i>Pistola GH 301 con swivel</i>
		Bent lance with detergent head, without nozzle <i>Lancia angolata con testina detergente, senza ugello</i>	
		Fan shape nozzle 15°, 1/4" MEG connection <i>Ugello con getto a lama 15° attacco 1/4" MEG</i>	
10 m rubber delivery hose kit <i>Kit tubo gomma mandata 10 m</i>		15 m rubber delivery hose kit <i>Kit tubo gomma mandata 15 m</i>	

BLUE SERIES PROFESSIONAL



# K Compact



## MOBILE - PICK UP - Kit STATIC



## MOBILE



### GENERAL FEATURES

- Easy maintenance by simply removing the front casing and taking the electrical pump unit out
- Big wheels (220 mm  $\varnothing$ ); easy to handle also up and down steps and over uneven ground
- Extractable 3.5 litre detergent tank with level that can be seen externally. Fitted with filter, adjustment knob and an external tank suction system
- **Pump with two oil sight glasses, external level viewer and brass pump head**
- 4-pole motor (1400 rpm) well oversized and protected with paint
- Integrated professional pressure unloader valve
- Self-priming pumps (with **EASY-START** device on single-phase models)
- Timed **TotalStop**
- Rotary switch
- Electrical panel with contactor and thermal relay
- Motor thermal cut-out



### CARATTERISTICHE GENERALI

- *Facilità di manutenzione, con la semplice rimozione della carenatura frontale ed estrazione del gruppo elettropompa*
- *Ruote di grandi dimensioni ( $\varnothing$  220 mm); estrema maneggevolezza anche su gradini e terreno accidentato*
- *Serbatoio detergente da 3,5 litri estraibile, con livello visibile dall'esterno. Dotato di filtro, manopola di regolazione e sistema per aspirazione da serbatoio esterno*
- **Pompa con doppio visore olio (livello visibile dall'esterno) e testata in ottone**
- *Motore a 4 poli (1400 giri/min) ampiamente sovradimensionato e protetto da verniciatura*
- *Valvola regolazione pressione professionale integrata*
- *Pompe autoadescenti (con dispositivo **EASY-START** sui modelli monofase)*
- **TotalStop** temporizzato
- *Interruttore rotativo*
- *Quadro elettrico con Teleruttore e Relè termico*
- *Protezione termica del motore*
- *Uso professionale*

- Pressure unloader valve with a large and practical knob
- Valvola regolazione pressione, con comoda e grande manopola di presa



- Well balanced for easy handling
- Estrema maneggevolezza grazie alla favorevole posizione del baricentro



- Pump with two oil sight glasses and external level viewer
- Pompa con doppio visore olio, con livello visibile dall'esterno



- Comet ZW-K pump with 3 integral ceramic pistons and brass pump head
- Pompa Comet ZW-K con 3 pistoni in ceramica integrale con testata in ottone



CODE CODICE	MODELS MODELLI											
		Ph	V	Hz	bar	MPa	l/h	CV	kW	l	kg	(L x W x H) cm
<b>K Compact Pick-Up</b>												
9050 0007	K Compact 3.11 M	1	230	50	120	12,0	660	3,0	2,9	3,5	37	57 x 42 x 47
9050 0008	K Compact 5.15 T	3	400	50	160	16,0	900	5,5	5,0	3,5	38	57 x 42 x 47
<b>K Compact Mobile</b>												
9050 0003	K Compact 3.11 M	1	230	50	120	12,0	660	3,0	2,9	3,5	37	63 x 54 x 93
9050 0002	K Compact 5.13 T	3	400	50	180	18,0	780	5,5	5,0	3,5	38	63 x 54 x 93
9050 0001	K Compact 5.15 T	3	400	50	160	16,0	900	5,5	5,0	3,5	38	63 x 54 x 93
<b>K Compact Mobile con avvolgitubo - with hose reel</b>												
9050 0004	K Compact 3.11 M	1	230	50	120	12,0	660	3,0	2,9	3,5	37	63 x 54 x 93
9050 0005	K Compact 5.13 T	3	400	50	180	18,0	780	5,5	5,0	3,5	38	63 x 54 x 93
9050 0006	K Compact 5.15 T	3	400	50	160	16,0	900	5,5	5,0	3,5	38	63 x 54 x 93

## PICK-UP



- Configuration for stationary use (on a pallet, on a base, on the ground)
- Easy to handle thanks to the practical built-in steel handles
- Configurazione per utilizzo stazionario (su pianale, su base, su terreno)
- Di facile movimentazione grazie alle comode maniglie in acciaio integrate nel telaio della macchina

## Kit STATIC



- Wall application kit with heavy duty tubular structure and hose reel
- Configuration for fixed washing points
- Kit applicazione a parete con struttura tubolare robusta ed affidabile con avvolgitubo
- Configurazione per postazioni fisse di lavaggio



### STANDARD ACCESSORIES > DOTAZIONE STANDARD



GH 351 gun with Swivel (n.2 o-ring)  
Pistola GH 351 con Swivel (n.2 o-ring)



Bent lance with detergent head, without nozzle  
Lancia angolata con testina detergente, senza ugello



Fan shape nozzle 15°, 1/4" MEG connection  
Ugello con getto a lama 15° attacco 1/4" MEG



Hose reel with rubber hose (15m for MOBILE models)  
Avvolgitubo girevole con tubo gomma (15m per modelli MOBILE)



Rubber delivery hose kit (8m for MOBILE models, 10m for PICK-UP models)  
Kit tubo gomma mandata (8m per modelli MOBILE, 10m per modelli PICK-UP)



# K Premium



## MOBILE - PICK UP - Kit STATIC



### PREMIUM



## MOBILE



### GENERAL FEATURES

- Easy maintenance by simply removing the front casing and taking the electrical pump unit out
- Big wheels (220 mm  $\varnothing$ ); easy to handle also up and down steps and over uneven ground
- Extractable 3.5 litre detergent tank with level that can be seen externally. Fitted with filter, adjustment knob and an external tank suction system
- **Pump with two oil sight glasses, external level viewer and brass pump head**
- 4-pole motor (1400 rpm) with double bearing, well oversized and protected with paint
- Flanged professional pressure unloader valve
- Timed **TotalStop**
- Rotary switch
- Electrical panel with contactor and thermal relay
- Motor thermal cut-out



### CARATTERISTICHE GENERALI

- *Facilità di manutenzione, con la semplice rimozione della carenatura frontale ed estrazione del gruppo elettropompa*
- *Ruote di grandi dimensioni ( $\varnothing$  220 mm); estrema maneggevolezza anche su gradini e terreno accidentato*
- *Serbatoio detergente da 3,5 litri estraibile, con livello visibile dall'esterno. Dotato di filtro, manopola di regolazione e sistema per aspirazione da serbatoio esterno*
- **Pompa con doppio visore olio, con livello visibile dall'esterno e testata in ottone**
- *Motore a 4 poli (1400 giri/min) con doppio cuscinetto ampiamente sovradimensionato e protetto da verniciatura*
- *Valvola regolazione pressione professionale flangiata*
- **TotalStop** temporizzato
- *Interruttore rotativo*
- *Quadro elettrico con Teleruttore e Relè termico*
- *Protezione termica del motore*
- *Uso professionale*

- Pressure unloader valve with a large and practical knob
- Valvola regolazione pressione, con comoda e grande manopola di presa



- Well balanced for easy handling
- Estrema maneggevolezza grazie alla favorevole posizione del baricentro



- Pump with two oil sight glasses and external level viewer
- Pompa con doppio visore olio, con livello visibile dall'esterno



- Comet RW Premium pump with 3 integral ceramic pistons and brass pump head
- Pompa Comet RW Premium con 3 pistoni in ceramica integrale e testata in ottone



CODE CODICE	MODELS MODELLI	Ph		V		Hz		bar		MPa		l/h		CV		kW		l		kg		(L x W x H) cm	
<b>K Premium Pick-Up</b>																							
9050 0513	K Premium 6.13 T	3	400	50	190	19,0	780	6,0	5,5	3,5	55	62 x 47 x 51											
9050 0514	K Premium 6.15 T	3	400	50	170	17,0	900	6,0	5,5	3,5	55	62 x 47 x 51											
9050 0515	K Premium 8.15 T	3	400	50	210	21,0	900	7,5	6,6	3,5	55	62 x 47 x 51											
9050 0540	K Premium 8.21 T	3	400	50	160	16,0	1260	7,5	6,9	3,5	55	62 x 47 x 51											
9050 0528	K Premium 9.15 T	3	400	50	230	23,0	900	9,0	7,3	3,5	55	62 x 47 x 51											
9050 0519	K Premium 9.21 T	3	400	50	180	18,0	1260	9,0	7,5	3,5	55	62 x 47 x 51											
<b>K Premium Mobile</b>																							
9050 0501	K Premium 6.13 T	3	400	50	190	19,0	780	6,0	5,5	3,5	55	63 x 59 x 96											
9050 0502	K Premium 6.15 T	3	400	50	170	17,0	900	6,0	5,5	3,5	55	63 x 59 x 96											
9050 0503	K Premium 8.15 T	3	400	50	210	21,0	900	7,5	6,6	3,5	55	63 x 59 x 96											
9050 0504	K Premium 8.21 T	3	400	50	160	16,0	1260	7,5	6,9	3,5	55	63 x 59 x 96											
9050 0505	K Premium 9.15 T	3	400	50	230	23,0	900	9,0	7,3	3,5	55	63 x 59 x 96											
9050 0506	K Premium 9.21 T	3	400	50	180	18,0	1260	9,0	7,5	3,5	55	63 x 59 x 96											
<b>K Premium Mobile con avvolgitubo - with hose reel</b>																							
9050 0507	K Premium 6.13 T	3	400	50	190	19,0	780	6,0	5,5	3,5	55	63 x 59 x 96											
9050 0508	K Premium 6.15 T	3	400	50	170	17,0	900	6,0	5,5	3,5	55	63 x 59 x 96											
9050 0509	K Premium 8.15 T	3	400	50	210	21,0	900	7,5	6,6	3,5	55	63 x 59 x 96											
9050 0510	K Premium 8.21 T	3	400	50	160	16,0	1260	7,5	6,9	3,5	55	63 x 59 x 96											
9050 0511	K Premium 9.15 T	3	400	50	230	23,0	900	9,0	7,3	3,5	55	63 x 59 x 96											
9050 0512	K Premium 9.21 T	3	400	50	180	18,0	1260	9,0	7,5	3,5	55	63 x 59 x 96											

## PICK-UP



- Configuration for stationary use (on a pallet, on a base, on the ground)
- Easy to handle thanks to the practical built-in steel handles
- Configurazione per utilizzo stazionario (su pianale, su base, su terreno)
- Di facile movimentazione grazie alle comode maniglie in acciaio integrate nel telaio della macchina

## Kit STATIC



- Wall application kit with heavy duty tubular structure and hose reel
- Configuration for fixed washing points
- Kit applicazione a parete con struttura tubolare robusta ed affidabile con avvolgitubo
- Configurazione per postazioni fisse di lavaggio

## STANDARD ACCESSORIES › DOTAZIONE STANDARD



GH 351 gun with Swivel (n.2 o-ring)  
Pistola GH 351 con Swivel (n.2 o-ring)



Bent lance with detergent head, without nozzle  
Lancia angolata con testina detergente, senza ugello



Fan shape nozzle 25°, 1/4" MEG connection  
Ugello con getto a lama 25° attacco 1/4" MEG



Hose reel with rubber hose (15m for MOBILE models)  
Avvolgitubo girevole con tubo gomma (15m per modelli MOBILE)



Rubber delivery hose kit (solo versione MOBILE e PICK-UP)  
Kit tubo gomma mandata 10 m (MOBILE and PICK-UP version)

K STEEL

# K 803 - 805 - 807 - 809 S



## GENERAL FEATURES

- Heavy duty structure with painted steel cover
- Handy and secure hose reel housing (when applicable) on top of the handle
- 4-pole motor (1400 rpm) well oversized and protected with paint
- Flanged professional pressure unloader valve **(K 809 only)**
- Self-priming ZW-K and FW2 pumps
- Integrated professional pressure unloader valve
- Exclusive pump-motor coupling system for intensive use **(K 809 only)**
- Contactor
- Motor thermal cut-out
- Overheating thermostatic valve



## CARATTERISTICHE GENERALI

- *Struttura robusta ed affidabile con cofano in acciaio verniciato*
- *Pratica e sicura collocazione dell'avvolgitubo (quando previsto) sul manubrio in posizione superiore*
- *Motore a 4 poli (1400 giri/min) ampiamente sovradimensionato e protetto da verniciatura*
- *Valvola regolazione pressione professionale flangiata (solo K 809)*
- *Pompe autoadescanti ZW-K e FW2*
- *Valvola regolazione pressione professionale integrata*
- *Esclusivo sistema accoppiamento pompa - motore per uso intensivo (solo K 809)*
- *Teleruttore*
- *Protezione termica motore*
- *Valvola termostatica di protezione da sovratemperatura*
- *Uso professionale*

- The hose reel can be mounted on the handle on request
- *A richiesta, possibilità di montaggio dell'avvolgitubo sul manubrio*



- Comet ZW-K pump with 3 integral ceramic pistons and brass pump head. Two oil sight glasses
- *Pompa Comet ZW-K con 3 pistoni in ceramica integrale con testata in ottone. Doppio visore livello olio*



- Comet FW2 pump with 3 integral ceramic pistons and brass pump head. Two oil sight glasses (**K809 models only**)
- *Pompa Comet FW2 con 3 pistoni in ceramica integrale con testata in ottone. Doppio visore livello olio (solo modelli K809)*



CODE CODICE	MODELS MODELLI										
		Ph	V	Hz	bar	MPa	l/h	CV	kW	kg	(L x W x H) cm
9024 4022	K 803 S 11/120 M	1	230	50	120	12,0	660	3,0	2,9	62	90 x 62 x 84
9024 4013	K 805 S 15/150 T	3	400	50	160	16,0	900	5,5	4,8	62	90 x 62 x 84
9024 4014	K 807 S 15/200 T	3	400	50	210	12,0	900	7,5	6,5	62	90 x 62 x 84
9024 4016	K 809 S 21/160 T	3	400	50	160	16,0	1260	7,5	7,0	66	90 x 62 x 84



**STANDARD ACCESSORIES › DOTAZIONE STANDARD**

<p>GC 251 gun with protection <i>Pistola GC 251 con protezione</i></p>	<p>Bent lance with detergent head, without nozzle <i>Lancia angolata con testina detergente, senza ugello</i></p>
<p>Fan shape nozzle 25°, 1/4" MEG connection <i>Ugello con getto a lama 25° attacco 1/4" MEG</i></p>	<p>10 m rubber delivery hose kit <i>Kit tubo gomma mandata 10 m</i></p>

K STEEL



# K 803 - 805 - 807 - 809 TS



# K 801 - 901 TS PREMIUM

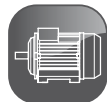

K 803 TS - K 805 TS - K 807 TS - K 809 TS

K 801 TS - K 901 TS



## GENERAL FEATURES

- Heavy duty structure **with stainless steel cover**
- Handy and secure housing of the hose reel (when applicable)
- Readily serviceable brass suction filter
- Pressure gauge
- 4-pole motor (1400 rpm) well oversized and protected with paint
- Integrated professional pressure unloader valve (**K 803- K 805 only**)
- Flanged professional pressure unloader valve (**K 807 - K 809 only**)
- Highly professional pressure unloader valve with external bypass (**K801 - K901 only**)
- Timed **TotalStop**
- **Exclusive pump-motor coupling system for intensive use (K 807 - K 809 - K801 - K901 only)**
- Contactor
- On - Off Switch
- Motor thermal cut-out

## CARATTERISTICHE GENERALI

- Struttura robusta ed affidabile **con cofano in acciaio inox**
- Pratica e sicura collocazione dell'avvolgitubo (quando previsto)
- Filtro aspirazione in ottone ispezionabile
- Manometro pressione
- Motore a 4 poli (1400 giri/min) ampiamente sovradimensionato e protetto da verniciatura
- Valvola regolazione pressione professionale integrata (**solo K 803- K 805**)
- Valvola regolazione pressione professionale flangiata (**solo K 807 - K 809**)
- Valvola regolazione pressione altamente professionale con by-pass esterno (**solo K801 - K901**)
- **TotalStop** temporizzato
- **Esclusivo sistema accoppiamento pompa - motore per uso intensivo (solo K 807 - K 809 - K801 - K901)**
- Teleruttore
- Interruttore per accensione
- Protezione termica motore
- Uso professionale



- Big pneumatic wheels (320 mm ø)
- Ruote pneumatiche di grandi dimensioni (ø320mm)



- Comet ZW-K pump with 3 integral ceramic pistons and brass pump head. Two oil sight glasses (K803-K805 models only)
- Pompa Comet ZW-K con 3 pistoni in ceramica integrale con testata in ottone. Doppio visore livello olio (solo modelli K803-K805)



- Comet FW2 pump with 3 integral ceramic pistons and brass pump head. Two oil sight glasses (K807-K809 models only)
- Pompa Comet FW2 con 3 pistoni in ceramica integrale con testata in ottone. Doppio visore livello olio (solo modelli K807-K809)



- Comet RW Premium pump with 3 integral ceramic pistons and brass pump head. Two oil sight glasses (K801 - K901 models only)

- Pompa Comet RW Premium con 3 pistoni in ceramica integrale con testata in ottone. Doppio visore livello olio (solo modelli K801 - K901)



CODE CODICE	MODELS MODELLI										
		Ph	V	Hz	bar	MPa	l/h	CV	kW	kg	(L x W x H) cm
9024 4021	K 803 TS 11/120 M	1	230	50	120	12,0	660	3,0	2,9	63	90 x 62 x 84
9024 4023	K 805 TS 15/160 T	3	400	50	160	16,0	900	5,5	4,8	63	90 x 62 x 84
9024 4024	K 807 TS 15/210 T	3	400	50	210	21,0	900	7,5	6,5	67	90 x 62 x 84
9024 4025	K 809 TS 21/160 T	3	400	50	160	16,0	1260	7,5	7,0	67	90 x 62 x 84
9024 4026	K 801 TS 15/230 T	3	400	50	230	23,0	900	9,0	7,3	70	90 x 62 x 84
9024 4027	K 901 TS 21/180 T	3	400	50	180	18,0	1260	9,0	7,3	70	90 x 62 x 84



STANDARD ACCESSORIES › DOTAZIONE STANDARD

<p>GH 351 gun with Swivel (n.2 o-ring) <i>Pistola GH 351 con Swivel (n.2 o-ring)</i></p>	<p>Bent lance with detergent head, without nozzle <i>Lancia angolata con testina detergente, senza ugello</i></p>
<p>Fan shape nozzle 25°, 1/4" MEG connection <i>Ugello con getto a lama 25° attacco 1/4" MEG</i></p>	<p>10 m rubber delivery hose kit <i>Kit tubo gomma mandata 10 m</i></p>
<p>Brass inlet water filter <i>Filtro aspirazione acqua in ottone</i></p>	

K STEEL

# K 809 - 801 - 901 ECO



## GENERAL FEATURES

- Handle with supports for housing the gun, lance, power cable and delivery hose
- Handy and secure housing of the hose reel (when applicable)
- 4-pole three-phase asynchronous motor (1400 rpm)
- **Exclusive pump-motor coupling system for intensive use**
- Flanged professional pressure unloader valve
- Contactor
- On-Off switch
- Motor thermal cut-out
- Timed **TotalStop**



## CARATTERISTICHE GENERALI

- Manico dotato di supporti per l'alloggiamento della pistola, della lancia, del cavo di alimentazione e del tubo mandata
- Pratica e sicura collocazione dell'avvolgitubo (quando previsto)
- Motore elettrico asincrono trifase 4 poli (1400 giri/min)
- **Esclusivo sistema di accoppiamento pompa-motore per uso intensivo**
- Valvola di regolazione pressione flangiata professionale
- Teleruttore
- Interruttore per accensione
- Protezione termica del motore elettrico
- **TotalStop** temporizzato
- Uso professionale

- Big wheels in food-industry rubber
- Ruote di grandi dimensioni con rivestimento in gomma antitraccia



- Pressure gauge with stainless steel casing
- Manometro pressione con cassa in acciaio inox



- Comet FW2 and RW Premium pumps with 3 integral ceramic pistons and brass pump head. Two oil sight glasses

- Pompe Comet FW2 e RW Premium con 3 pistoni in ceramica integrale con testata in ottone. Doppio visore livello olio



- The hose reel can be mounted on the handle on request

- A richiesta, possibilità di montaggio dell'avvolgitubo sul manubrio



CODE CODICE	MODELS MODELLI										
		Ph	V	Hz	bar	MPa	l/h	CV	kW	kg	(L x W x H) cm
9024 4725	K 809 ECO 21/150	3	400	50	160	16,0	1260	7,5	7,0	67	90 x 62 x 84
9024 4726	K 801 ECO 15/210	3	400	50	210	21,0	900	9,0	7,5	70	90 x 62 x 84
9024 4727	K 901 ECO 21/180	3	400	50	180	18,0	1260	9,0	7,5	70	90 x 62 x 84



STANDARD ACCESSORIES > DOTAZIONE STANDARD



Stainless steel GH 351 gun with Swivel and ball quick coupler  
Pistola GH 351 inox con Swivel + attacco rapido a sfere



Stainless steel bent lance, adjustable head, with ball quick coupler without nozzle  
Lancia angolata inox, testina regolabile + attacco rapido a sfere senza ugello



S. Steel fan shape nozzle 25°, 1/4" MEG connection (max 350 bar)  
Ugello inox con getto a lama 25° attacco 1/4" MEG (max 350 bar)



Anti-trace BLUE 10 m rubber delivery hose kit  
Kit tubo gomma mandata 10 m BLU anti-traccia



Brass inlet water filter  
Filtro aspirazione acqua in ottone

K STEEL

# K 1001 - 1251 - 1501 TS



## PREMIUM



### GENERAL FEATURES

- Heavy duty structure **with stainless steel cover**
- High filtering capacity cartridge self-cleaning suction filter
- Pressure gauge with stainless steel casing
- 4-poles 50Hz (1400 rpm) motor well oversized and protected with paint
- Highly professional pressure unloader valve with external bypass
- Motor-pump coupling by means of a flexible joint
- Timed **TotalStop** FLOW-SENSITIVE
- Low voltage control panel
- Contactor
- Motor protected with a thermal relay



### CARATTERISTICHE GENERALI

- **Struttura robusta ed affidabile con cofano in acciaio inox**
- **Filtro aspirazione autopulente a cartuccia di alta portata, con alto potere filtrante**
- **Manometro pressione con cassa in inox**
- **Motore a 4 poli (1400 giri/min) ampiamente sovradimensionato e protetto da verniciatura**
- **Valvola regolazione pressione altamente professionale con by-pass esterno**
- **Accoppiamento motore-pompa mediante giunto elastico**
- **TotalStop temporizzato FLOW-SENSITIVE**
- **Quadri Comando in bassa tensione**
- **Teleruttore**
- **Protezione del motore con relè termico**
- **Uso professionale continuo**

- The stainless steel hose reel can be mounted on request, with 20-40-60 m hose.
- *A richiesta, possibilità di montaggio dell'avvolgitubo interamente in acciaio inox con tubo da 20, 40, 60 metri.*

- Practical and safe housing accessories, all with ball quick coupler
- *Pratico e sicuro alloggiamento degli accessori, tutti con attacco rapido a sfere*

- Valve and pressure accumulator
- *Valvola e accumulatore di pressione*

- Stainless steel frame on request
- *A richiesta, fornibile con telaio inox*



CODE CODICE	MODELS MODELLI										
		Ph	V	Hz	bar	MPa	l/h	CV	kW	kg	(L x W x H) cm
9059 00351	K 1001 TS 21/210	3	400	50	210	21,0	1260	10	8,5	158	90 x 75 x 95
9059 00352	K 1001 TS 28/160	3	400	50	160	16,0	1680	10	8,5	158	90 x 75 x 95
9059 00353	K 1251 TS 21/250	3	400	50	250	25,0	1260	12	10,0	161	90 x 75 x 95
9059 00354	K 1251 TS 33/160	3	400	50	160	16,0	1980	12	10,0	161	90 x 75 x 95
9059 00355	K 1501 TS 42/130	3	400	50	130	13,0	2520	15	12,0	163	90 x 75 x 95

**STANDARD ACCESSORIES › DOTAZIONE STANDARD**

	RL51gun with swivel and ball quick coupler <i>Pistola RL 51 con Swivel + attacco rapido a sfere</i>		Stainless steel double barrel lance with ball quick coupler, without nozzle <i>Lancia canna doppia inox con attacco rapido a sfere, senza ugello</i>
	Fan shape nozzle 25°, 1/4" MEG connection (max 350 bar) <i>Ugello con getto a lama 25° attacco 1/4" MEG (max 350 bar)</i>		Detergent nozzle for double barrel lance, 1/4" MEG connection <i>Ugello detergente per lancia canna doppia, attacco 1/4" MEG</i>
	Self cleaning water filter <i>Filtro acqua autopulente</i>		Cartridge for water filter <i>Cartuccia per filtro acqua</i>
		Delivery rubber hose kit, with M22x1,5 quick coupler <i>Kit tubo gomma mandata, con attacco rapido M22x1,5</i>	

K STEEL



# K Xtreme



## PREMIUM



### GENERAL FEATURES

- Sturdy frame painted with anti-corrosive treatment
- **Stainless-steel cladding panel**
- Handy lance and gun storage
- High filtering capacity cartridge self-cleaning suction filter
- Pneumatic wheels with steel hub and air chamber
- Electric motor (1400 rpm) 20 and 25 HP
- Comet TW Premium triplex pumps
- Motor-pump coupling by means of a flexible joint
- *Automatic pressure unloader valve with external by-pass (pressure resetting on 25 HP models)*
- *Overheating thermostatic valve*
- **Low voltage (24V) industrial start-up panel (star-delta on 25 HP models)**
- Remote switch and motor cut-out with thermal relay
- Emergency stop button
- Hour counter



### CARATTERISTICHE GENERALI

- *Robusto telaio verniciato con trattamenti anticorrosivi*
- **Pannello di rivestimento in acciaio inox**
- *Pratico alloggiamento di pistola e lancia*
- *Filtro aspirazione autopulente a cartuccia di alta portata, con alto potere filtrante*
- *Motore elettrico (1400 giri/min) 20 e 25 HP*
- *Pompe triplex Comet TW Premium*
- *Accoppiamento motore pompa mediante giunto elastico*
- *Valvola automatica di regolazione pressione con by-pass esterno (azzeramento pressione su modelli 25 HP)*
- *Valvola termostatica di protezione da sovratemperatura*
- **Quadro di avviamento diretto con comandi in bassa tensione (24V), (stella triangolo su modelli 25 HP)**
- *Teleruttore e protezione del motore con relè termico*
- *Pulsante di arresto di emergenza*
- *Contaore*
- *Uso altamente professionale*

- Motor-pump coupling with a flexible joint
- *Accoppiamento motore pompa mediante giunto elastico*



- The hose reel can be mounted on request
- *A richiesta, possibilità di montaggio dell'avvolgitubo*



- Comet TW Premium pump with 3 integral ceramic pistons and brass pump head. Two oil sight glasses
- *Pompa Comet TW Premium con 3 pistoni in ceramica integrale con testata in ottone. Doppio visore livello olio*



CODE CODICE	MODELS MODELLI										
		Ph	V	Hz	bar	MPa	l/h	CV	kW	kg	(L x W x H) cm
9059 0001	K Xtreme 15/500	3	400	50	500	50,0	900	20,0	15,0	175	100 x 75 x 85
9059 0002	K Xtreme 21/350	3	400	50	350	35,0	1260	20,0	15,0	175	100 x 75 x 85
9059 0003	K Xtreme 33/250	3	400	50	250	25,0	1980	20,0	15,0	175	100 x 75 x 85
9059 0004	K Xtreme 18/500	3	400	50	500	50,0	1080	25,0	18,5	185	100 x 75 x 85
9059 0005	K Xtreme 21/450	3	400	50	450	45,0	1260	25,0	18,5	185	100 x 75 x 85
9059 0006	K Xtreme 42/200	3	400	50	200	20,0	2520	25,0	18,5	185	100 x 75 x 85

On request, available 440V 60Hz models - *Disponibili su richiesta modelli a 440V 60Hz*



**STANDARD ACCESSORIES › DOTAZIONE STANDARD**

	Pistola GH 501 inox con attacchi rapidi <i>Stainless steel GH 501 Spray gun with quick couplers</i>		Lancia Inox dritta, con impugnatura regolabile <i>Straight S.Steel Lance, with adjustable handle</i>
15°-25° 	Flat stainless-steel jet nozzle (15° or 25°) with ceramic insert (available on request in s/s-tungsten material) <i>Ugello inox getto piatto 15° o 25° con inserto in ceramica (disponibile su richiesta in materiale inox/tungsteno)</i>		Delivery hose kit with quick coupler M24x1,5 <i>Kit tubo mandata con attacchi rapidi M24x1,5</i>
	Self cleaning water filter <i>Filtro acqua autopulente</i>		Cartridge for water filter <i>Cartuccia per filtro acqua</i>

K STEEL

# K 2000 - 2500 TS



## PREMIUM



### GENERAL FEATURES

- Sturdy frame consisting of tubular and sheet metal painted with anti-corrosive treatment
- **AISI 304 stainless steel cladding panels**
- Handy lance and gun storage
- High filtering capacity cartridge suction filter
- Electric motor (1400 rpm), eff. class IE2
- Comet TW Premium and HPP CH triplex pumps
- Motor-pump coupling with a flexible joint
- Automatic pressure unloader valve with external bypass
- Overheating thermostatic valve
- **Direct starting panel with low voltage controls (24V)**
- Contactor and motor cut-out with a thermal relay
- Emergency stop button
- Hour counter

### CARATTERISTICHE GENERALI

- **Robusto telaio composto da lamiere e tubolari verniciati con trattamenti anticorrosivi**
- **Pannelli di rivestimento in acciaio inox AISI 304**
- **Pratico alloggiamento di pistola e lancia**
- **Filtro aspirazione a cartuccia di alta portata, con alto potere filtrante**
- **Motore elettrico (1400 giri/min), eff. IE2**
- **Pompe triplex Comet TW Premium e HPP CH**
- **Accoppiamento motore pompa mediante giunto elastico**
- **Valvola automatica di regolazione pressione con by-pass esterno**
- **Valvola termostatica di protezione da sovratemperatura**
- **Quadro di avviamento diretto con comandi in bassa tensione (24V)**
- **Teleruttore e protezione del motore con relè termico**
- **Pulsante di arresto di emergenza**
- **Contaore**
- **Uso altamente professionale**



- Highly professional joint for motor-pump coupling.
- *Giunto di collegamento (estremamente professionale) tra Motore elettrico e pompa.*



- Comet TW Premium pump with 3 integral ceramic pistons and brass pump head. Two oil sight glasses
- *Pompa Comet TW Premium con 3 pistoni in ceramica integrale con testata in ottone. Doppio visore livello olio*



- Comet HPP CH H.P. pump (K 2500 - 30/300 T models only)
- *Pompa Comet HPP CH ad alta pressione (solo modelli K 2500 - 30/300 T)*



CODE CODICE	MODELS MODELLI										
		Ph	V	Hz	bar	MPa	l/h	CV	kW	kg	(L x W x H) cm
9056 0001	K 2000 15/500 TS	3	400	50	500	50,0	900	20,0	15,0	280	145 x 88 x 95
9056 0002	K 2000 18/400 TS	3	400	50	400	40,0	1080	20,0	15,0	280	145 x 88 x 95
9056 0003	K 2000 21/350 TS	3	400	50	350	35,0	1260	20,0	15,0	280	145 x 88 x 95
9056 0005	K 2500 21/450 TS	3	400	50	450	45,0	1260	25,0	18,5	280	145 x 88 x 95
9056 0004	K 2500 30/300 TS	3	400	50	300	30,0	1800	25,0	18,5	330	145 x 88 x 95



**STANDARD ACCESSORIES › DOTAZIONE STANDARD**

	Pistola GH 501 inox con attacchi rapidi <i>Stainless steel GH 501 Spray gun with quick couplers</i>		Lancia Inox dritta, con impugnatura regolabile <i>Straight S.Steel Lance, with adjustable handle</i>
15°-25° 	Flat stainless-steel jet nozzle (15° or 25°) with ceramic insert (available on request in s/s-tungsten material) <i>Ugello inox getto piatto 15° o 25° con inserto in ceramica (disponibile su richiesta in materiale inox/tungsteno)</i>		Delivery hose kit with quick coupler M24x1,5 <i>Kit tubo mandata con attacchi rapidi M24x1,5</i>
	Water filter <i>Filtro acqua</i>		Cartridge for water filter <i>Cartuccia per filtro acqua</i>



# FDX 2



2 ruote - wheels



## FDX 2 10/150 - VRX

### GENERAL FEATURES - CARATTERISTICHE GENERALI

- Honda GC 160 Engine
- **Comet VRX 3 axial piston pump with brass pump head**
- Readily serviceable suction filter
- Professional unloader valve
- **Motore Honda GC 160**
- **Pompa Comet a 3 pistoni assiali VRX, con testata in ottone**
- **Filtro aspirazione ispezionabile**
- **Valvola regolazione professionale**
- **Usò semiprofessionale**

## FDX 2 12/200 - BXD

### GENERAL FEATURES - CARATTERISTICHE GENERALI

- Loncin GC 200 F Engine
- No engine-oil safety device (oil-alert)
- **Comet BXD self-priming pump with 3 axial integral ceramic pistons and brass pump head**
- Regulated low-pressure detergent suction
- Readily serviceable suction filter
- Professional unloader valve
- **Motore Loncin GC 200 F**
- **Dispositivo di sicurezza mancanza olio motore**
- **Pompa Comet BXD autoadescante con 3 pistoni assiali in ceramica e testata in ottone**
- **Aspirazione detergente in bassa pressione con regolazione**
- **Filtro aspirazione ispezionabile**
- **Valvola regolazione professionale**
- **Usò semiprofessionale**

## FDX 2 - BXD / AXD

### GENERAL FEATURES - CARATTERISTICHE GENERALI

- Honda GC or GX series engine
- No engine-oil safety device (oil-alert) (GX models only)
- **Comet BXD-AXD self-priming pumps with 3 axial ceramic pistons and brass pump head**
- Regulated low-pressure detergent suction
- Readily serviceable suction filter
- Professional unloader valve
- **Motore Honda serie GC o GX**
- **Dispositivo di Sicurezza mancanza olio motore (solo modelli GX)**
- **Pompe Comet BXD-AXD autoadescanti con 3 pistoni assiali in ceramica e testata in ottone**
- **Aspirazione detergente in bassa pressione con regolazione**
- **Filtro aspirazione ispezionabile**
- **Valvola regolazione professionale**
- **Usò semiprofessionale**

## FDX 2 - BWD-K / ZWD / ZWD-K

### GENERAL FEATURES - CARATTERISTICHE GENERALI

- Honda GX series engine
- No engine-oil safety device (oil-alert)
- **Comet BWD, ZWD, ZWD-K self-priming triplex pumps, 3 ceramic pistons, brass pump head, bronze conrods**
- Regulated low-pressure detergent suction
- Readily serviceable suction filter
- Professional unloader valve
- **Motore Honda serie GX**
- **Dispositivo di Sicurezza mancanza olio motore**
- **Pompe Comet BWD, ZWD, ZWD-K triplex autoadescanti, 3 pistoni in ceramica, testata ottone, bielle in bronzo**
- **Aspirazione detergente in bassa pressione con regolazione**
- **Filtro aspirazione ispezionabile**
- **Valvola regolazione professionale**
- **Usò semiprofessionale**

- Easy to handle up and down steps and over uneven ground
- *Facilità di movimento su gradini e fondi sconnessi*

- Well balanced for easy handling
- *Estrema maneggevolezza grazie alla favorevole posizione del baricentro*



CODE CODICE	MODELS MODELLI						
		bar	MPa	l/h	CV	kg	(L x W x H) cm
9020 0093	FDX 2 10/150 - VRX - Honda GC160	150	15,0	540	5,0	27	67 x 55 x 89
9020 0156	FDX 2 12/200 - BXD - Loncin GC 200 F	200	20,0	720	6,0	30	67 x 55 x 89
9020 0301	FDX 2 11/150 - BXD - Honda GC160	150	15,0	660	5,0	30	67 x 55 x 89
9020 0302	FDX 2 13/150 - BXD - Honda GC160	150	15,0	780	5,0	30	67 x 55 x 89
9020 0303	FDX 2 12/170 - BXD - Honda GC160	170	17,0	720	5,0	30	67 x 55 x 89
9020 0304	FDX 2 14/200 - AXD - Honda GX270	200	20,0	840	9,0	40	67 x 55 x 89
9020 0305	FDX 2 12/140 - BWD-K /Honda GX160	140	14,0	720	5,5	30	67 x 55 x 89
9020 0306	FDX 2 13/180 - BWD-K /Honda GX200	180	18,0	780	6,0	34	67 x 55 x 89
9020 0307	FDX 2 14/190 - ZWD-K /Honda GX270	200	20,0	840	9,0	40	67 x 55 x 89
9020 0308	FDX 2 16/210 - ZWD-K /Honda GX340	210	21,0	960	11,0	48	67 x 55 x 89
9020 0309	FDX 2 16/250 - ZWD - Honda GX390	250	25,0	960	13,0	50	67 x 55 x 89
9020 0310	FDX 2 15/270 - ZWD-K /Honda GX390	270	27,0	900	13,0	50	67 x 55 x 89



STANDARD ACCESSORIES › DOTAZIONE STANDARD

FDX 2 10/150 - VRX

FDX 2 12/200 - BXD

FDX 2 - BXD / AXD  
BWD-K / ZWD / ZWD-K

	Gun with protection <i>Pistola con protezione</i>
	Lance with adjustable nozzle <i>Lancia con ugello regolabile</i>
	Nozzle, for possible parts replacement <i>Ugello per lancia, per eventuale ricambio</i>
	8 m rubber delivery hose kit <i>Kit tubo gomma mandata 8 m</i>
	Foam lance <i>Lancia schiumogena</i>

	Gun GC 251 with protection <i>Pistola con protezione GC 251</i>
	Bent lance with detergent head, without nozzle <i>Lancia angolata con testina detergente, senza ugello</i>
	Fan shape nozzle 15°, 1/4" MEG connection <i>Ugello con getto a lama 15°, attacco 1/4" MEG</i>
	8 m rubber delivery hose kit <i>Kit tubo gomma mandata 8 m</i>

	GH 301 gun with Swivel <i>Pistola GH 301 con Swivel</i>
	Bent lance with detergent head, without nozzle <i>Lancia angolata con testina detergente, senza ugello</i>
	Fan shape nozzle 25°, 1/4" MEG connection <i>Ugello con getto a lama 25°, attacco 1/4" MEG</i>
	8 m rubber delivery hose kit (10 m for 14/200 - 12/140 - 13/180 14/190 - 16/210 - 16/250 15/270 models) <i>Kit tubo gomma mandata 8 m (10 m per modelli 14/200 - 12/140 13/180 - 14/190 - 16/210 16/250 - 15/270)</i>

X SPECIAL



# FDX ELITE



## 4 ruote - wheels



### GENERAL FEATURES

- **With 4 wheels 2 of which castors**
- Pump protection casing
- Handle with practical supports for housing the gun, lance and delivery hose
- Low-pressure detergent suction
- Readily serviceable water filter
- No engine-oil safety device (oil-alert)
- Water suction from external tank option (self-priming pumps)
- Professional pressure unloader valve
- Overheating thermostatic valve



### CARATTERISTICHE GENERALI

- **Con 4 ruote di cui 2 pivotanti**
- Carenatura di protezione della pompa
- Manico dotato di pratici supporti per l'alloggiamento della pistola, della lancia e del tubo mandata
- Aspirazione del detergente in bassa pressione
- Filtro acqua ispezionabile
- Dispositivo di sicurezza mancanza olio motore (oil-alert)
- Possibilità di aspirare acqua da serbatoio esterno (pompe autoadescanti)
- Valvola di regolazione della pressione professionale
- Valvola termostatica di protezione da sovratemperatura
- Uso semiprofessionale

- Easy handling thanks to the big pneumatic wheels
- *Facilità di movimento grazie alle ruote pneumatiche di grandi dimensioni*



- Comet AXD, LWD-K and ZWD-K pumps with 3 ceramic pistons and brass pump head
- *Pompe Comet AXD, LWD-K e ZWD-K con 3 pistoni in ceramica e testata in ottone*



- The hose reel can be mounted on the handle on request
- *A richiesta, possibilità di montaggio dell'avvolgitubo sul manubrio*



CODE CODICE	MODELS MODELLI						
		bar	MPa	l/h	CV	kg	(L x W x H) cm
9020 0501	FDX ELITE 11/150 - AXD - Honda GC160	150	15,0	660	5,0	35	90 x 62 x 84
9020 0503	FDX ELITE 13/150 - AXD - Honda GX160	150	15,0	780	5,5	38	90 x 62 x 84
9020 0502	FDX ELITE 12/170 - AXD - Honda GX160	170	17,0	720	5,5	38	90 x 62 x 84
9020 0506	FDX ELITE 14/200 - AXD - Honda GX270	200	20,0	840	9,0	48	90 x 62 x 84
9020 0504	FDX ELITE 12/140 - LWD-K / Honda GX160	140	14,0	720	5,5	38	90 x 62 x 84
9020 0510	FDX ELITE 13/180 - LWD-K / Honda GX200	180	18,0	780	6,0	42	90 x 62 x 84
9020 0505	FDX ELITE 14/190 - ZWD-K / Honda GX270	200	20,0	840	9,0	48	90 x 62 x 84
9020 0507	FDX ELITE 16/210 - ZWD-K / Honda GX340	210	21,0	960	11,0	58	90 x 62 x 84
9020 0508	FDX ELITE 16/250 - ZWD - Honda GX390	250	25,0	960	13,0	58	90 x 62 x 84
9020 0509	FDX ELITE 15/270 - ZWD-K / Honda GX390	270	27,0	900	13,0	58	90 x 62 x 84

**STANDARD ACCESSORIES › DOTAZIONE STANDARD**

	GH 301 gun with Swivel <i>Pistola GH 301 con Swivel</i>		Bent lance with detergent head, without nozzle <i>Lancia angolata con testina detergente, senza ugello</i>
	Fan shape nozzle 25°, 1/4" MEG connection <i>Ugello con getto a lama 25°, attacco 1/4" MEG</i>		10 m rubber delivery hose kit <i>Kit tubo gomma mandata 10 m</i>
	Thermostatic Valve (optimal functioning when supplied with tap water pressure) <i>Valvola termostatica (funzionamento ottimale solo se alimentata in pressione)</i>		

X SPECIAL



# FDX PRO



## 4 ruote - wheels



## PREMIUM



### GENERAL FEATURES

- With 4 wheels of which 2 castors
- Honda GX series engine (petrol models) or Yanmar L70 engine (Diesel model)
- No engine-oil safety device (oil-alert) (Honda engine only)
- **Automatic decelerator to reduce the number of revs in the bypass phase (on petrol engines)**
- **Gearbox (with 1560 rpm pump) (Honda engine only)**
- Regulated low-pressure detergent suction
- Readily serviceable brass suction filter
- Water suction from external tank option (self-priming pumps)



### CARATTERISTICHE GENERALI

- Con 4 ruote di cui 2 pivotanti
- Motore Honda serie GX (modelli a benzina) o Yanmar L70 (modello Diesel)
- Dispositivo di Sicurezza mancanza olio motore (solo motore Honda)
- **Deceleratore automatico per la riduzione del numero di giri in fase di by-pass (su motori benzina)**
- **Riduttore di giri (con pompa a 1560 rpm) (solo motore Honda)**
- Aspirazione del detergente in bassa pressione con regolazione
- Filtro aspirazione in ottone facilmente ispezionabile
- Possibilità di aspirare acqua da serbatoio esterno (pompe autoadescanti)
- Uso professionale

- Easy handling thanks to the big pneumatic wheels
- *Facilità di movimento grazie alle ruote pneumatiche di grandi dimensioni*



- Comet RW Premium, FW2 pumps with 3 ceramic pistons and brass pump head
- *Pompe Comet RW Premium, FW2 con 3 pistoni in ceramica e testata in ottone*



- The hose reel can be mounted on the handle on request
- *A richiesta possibilità di montaggio dell'avvolgitubo sul manubrio*

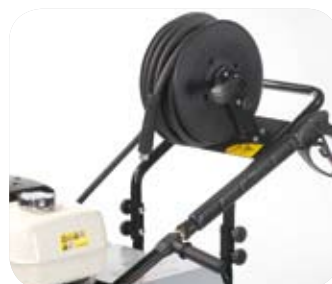

- RPM deceleration kit
- *Kit deceleratore di giri motore*



CODE CODICE	MODELS MODELLI						
		bar	MPa	l/h	CV	kg	(L x W x H) cm
<b>Diesel Engines - Motori diesel</b>							
9020 0114	FDX PRO 15/150 - ZWD-K / Yanmar L70	150	15,0	900	7,5	60	116 x 62 x 71
<b>Petrol engines - Motori a benzina</b>							
9020 0132	FDX PRO 15/270 - RW - Honda GX390	270	27,0	900	13,0	82	116 x 62 x 71
9020 0146	FDX PRO 15/270 - RW - Honda GX390 + AVT	270	27,0	900	13,0	87	116 x 62 x 71
9020 0144	FDX PRO 15/300 - RW - Honda GX390	300	30,0	900	13,0	82	116 x 62 x 71
9020 0145	FDX PRO 15/300 - RW - Honda GX390 + AVT	300	30,0	900	13,0	87	116 x 62 x 71
9020 0087	FDX PRO 16/200 - FW2 - Honda GX340	200	20,0	960	11,0	82	116 x 62 x 71
9020 0090	FDX PRO 16/200 - FW2 - Honda GX340 + AVT	200	20,0	960	11,0	87	116 x 62 x 71
9020 0116	FDX PRO 16/250 - RW - Honda GX390	250	25,0	960	13,0	82	116 x 62 x 71
9020 0117	FDX PRO 16/250 - RW - Honda GX390 + AVT	250	25,0	960	13,0	87	116 x 62 x 71
9020 0118	FDX PRO 18/220 - RW - Honda GX390	220	22,0	1080	13,0	82	116 x 62 x 71
9020 0119	FDX PRO 18/220 - RW - Honda GX390 + AVT	220	22,0	1080	13,0	87	116 x 62 x 71



**STANDARD ACCESSORIES › DOTAZIONE STANDARD**

	GH 351 gun with Swivel (n.2 o-ring) <i>Pistola GH 351 con Swivel (n.2 o-ring)</i>		Double barrel lance, without nozzle <i>Lancia a canna doppia senza ugello</i>
	Fan shape nozzle 25°, 1/4" MEG connection <i>Ugello con getto a lama 25° attacco 1/4" MEG</i>		Detergent nozzle for double barrel lance, 1/4" MEG connection <i>Ugello detergente per lancia canna doppia, attacco 1/4" MEG</i>
	10 m SAE 100 rubber delivery hose kit <i>(for models without hose reel)</i> <i>Kit tubo gomma mandata, SAE 100 - 10 m</i> <i>(per modelli senza avvolgitubo)</i>		15 m hose reel <i>(for models with hose reel)</i> <i>Avvolgitubo 15 m</i> <i>(per modelli con avvolgitubo)</i>
		Brass inlet water filter <i>Filtro aspirazione acqua in ottone</i>	

X SPECIAL



# FDX 4



## 4 ruote - wheels



## PREMIUM



### GENERAL FEATURES

- With 4 pneumatic wheels
- Honda GX series engine (petrol models) or Yanmar L100 engine (Diesel model)
- **Electrical starting**
- No engine-oil safety device (oil-alert)
- **Automatic decelerator to reduce the number of revs in the bypass phase (on petrol engines)**
- **Gearbox (with 1560 rpm pump)**
- Regulated low-pressure detergent suction
- Big water filter at pump inlet
- Water suction from external tank option (self-priming pumps)



### CARATTERISTICHE GENERALI

- Con 4 ruote pneumatiche
- Motore Honda Serie GX (modelli a benzina) o Yanmar L100 (modello Diesel)
- **Avviamento elettrico**
- Dispositivo di Sicurezza mancanza olio motore
- **Deceleratore automatico per la riduzione del numero di giri in fase di by-pass (su motori benzina)**
- **Riduttore di giri (con pompa a 1560 rpm)**
- Aspirazione detergente in bassa pressione con regolazione
- Filtro acqua di grande dimensione in ingresso pompa
- Possibilità di aspirare acqua da serbatoio esterno (pompe autoadescenti)
- **Uso professionale**



- Easy handling thanks to the big pneumatic wheels
- *Facilità di movimento grazie alle ruote pneumatiche di grandi dimensioni*



- Comet RW Premium, FW2 pumps with 3 ceramic pistons and brass pump head
- *Pompe Comet RW Premium, FW2 con 3 pistoni in ceramica e testata in ottone*



- RPM deceleration kit only for petrol engine models
- *Kit deceleratore di giri motore solo modelli motore a benzina*



CODE CODICE	MODELS MODELLI						
		bar	MPa	l/h	CV	kg	(L x W x H) cm
<b>Diesel Engines - Motori diesel</b>							
9020 0057	FDX 4 16/200 - FW2 - Yanmar L100 - Diesel with electrical and battery starting con avviamento elettrico e batteria	200	20,0	960	11,0	124	89 x 77 x 86
9020 0070	FDX 4 21/160 - FW2 - Yanmar L100 - Diesel with electrical and battery starting con avviamento elettrico e batteria	160	16,0	1260	11,0	124	89 x 77 x 86
<b>Petrol engines - Motori a benzina</b>							
9020 0049	FDX 4 16/200 - FW2 - Honda GX340 with decelerator - con deceleratore	200	20,0	960	11,0	72	89 x 77 x 86
9020 0121	FDX 4 16/250 - RW - Honda GX390 with electrical and battery starting and decelerator con avviam. elett., batteria e deceleratore	250	25,0	960	13,0	82	89 x 77 x 86
9020 0120	FDX 4 16/250 - RW - Honda GX390 with decelerator - con deceleratore	250	25,0	960	13,0	72	89 x 77 x 86
9020 0150	FDX 4 18/220 - RW - Honda GX390 with electrical and battery starting and decelerator con avviam. elett., batteria e deceleratore	220	22,0	1080	13,0	82	89 x 77 x 86
9020 0123	FDX 4 18/220 - RW - Honda GX390 with decelerator - con deceleratore	220	22,0	1080	13,0	72	89 x 77 x 86
9020 0152	FDX 4 21/200 - RW - Honda GX390 with electrical and battery starting and decelerator con avviam. elett., batteria e deceleratore	200	20,0	1260	13,0	82	89 x 77 x 86
9020 0151	FDX 4 21/200RW - Honda GX340 with decelerator - con deceleratore	200	20,0	1260	13,0	82	89 x 77 x 86



**STANDARD ACCESSORIES › DOTAZIONE STANDARD**

	GH 351 gun with Swivel (n.2 o-ring) <i>Pistola GH 351 con Swivel (n.2 o-ring)</i>		Double barrel lance, without nozzle <i>Lancia a canna doppia senza ugello</i>
	Fan shape nozzle 25°, 1/4" MEG connection <i>Ugello con getto a lama 25° attacco 1/4" MEG</i>		Detergent nozzle for double barrel lance, 1/4" MEG connection <i>Ugello detergente per lancia canna doppia, attacco 1/4" MEG</i>
	10 m rubber delivery hose kit <i>Kit tubo gomma mandata 10 m</i>		Brass inlet water filter <i>Filtro aspirazione acqua in ottone</i>

X SPECIAL



# FDX Xtreme



## 4 ruote - wheels



### PREMIUM

POWERED by  
**HONDA**



#### GENERAL FEATURES

- 4 wheels with foamed-acting pneumatic
- Honda GX 690 4-stroke two cylinder net 22HP engine
- **Gearbox (with 1560 rpm pump)**
- **Electrical starting**
- No engine-oil safety device (oil-alert)
- **Pressure reset valve**
- **Thermostatic valve**
- Big water filter at pump inlet, readily serviceable cartridge type
- Water suction from external tank option (self-priming pumps)



#### CARATTERISTICHE GENERALI

- 4 ruote schiumate con effetto pneumatico
- Motore Honda GX 690 4 tempi bicilindrico 22 CV netti
- **Riduttore di giri (con pompa a 1560 rpm)**
- **Avviamento elettrico**
- Dispositivo di Sicurezza mancanza olio motore
- **Valvola azzeramento pressione**
- **Valvola termostatica**
- Filtro acqua di grande dimensione in ingresso pompa a cartuccia ispezionabile
- Possibilità di aspirare acqua da serbatoio esterno (pompe autoadescenti)
- **Uso altamente professionale**

- Rear wheel with brake
- *Ruota posteriore dotata di freno*

- Comet TW 500 bar Premium pump with 3 ceramic plungers and brass pump head
- *Pompa Comet TW 500 bar Premium, con 3 pistoni in ceramica e testata in ottone*

- The hose reel can be mounted on request
- *A richiesta possibilità di montaggio dell'avvolgitubo*

- Motor pump unit with battery
- *Gruppo motopompa con batteria*

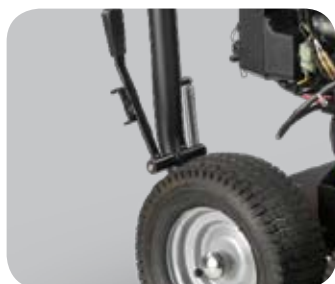

CODE CODICE	MODELS MODELLI						
		bar	MPa	l/h	CV	kg	(L x W x H) cm
9058 0001	FDX Xtreme 15/500 - TW 500	500	50,0	900	24,0	150	100 x 82 x 85
9058 0002	FDX Xtreme 18/400 - TW 500	400	40,0	1080	24,0	150	100 x 82 x 85
9058 0003	FDX Xtreme 21/350 - TW 500	350	35,0	1260	24,0	150	100 x 82 x 85
9058 0004	FDX Xtreme 30/280 - TW	280	28,0	1800	24,0	150	100 x 82 x 85
9058 0005	FDX Xtreme 36/230 - TW	230	23,0	2160	24,0	150	100 x 82 x 85
9058 0006	FDX Xtreme 42/180 - TW	180	18,0	2520	24,0	150	100 x 82 x 85

**STANDARD ACCESSORIES › DOTAZIONE STANDARD**

	Pistola GH 501 inox con attacchi rapidi <i>Stainless steel GH 501 Spray gun with quick couplers</i>		Lancia Inox dritta, con impugnatura regolabile <i>Straight S.Steel Lance, with adjustable handle</i>
	Flat stainless-steel jet nozzle (15° or 25°) with ceramic insert (available on request in s/s-tungsten material) <i>Ugello inox getto piatto 15° o 25° con inserto in ceramica (disponibile su richiesta in materiale inox/tungsteno)</i>		20 m delivery hose kit with quick coupler M24x1,5 <i>Kit tubo mandata con attacchi rapidi M24x1,5 - 20 m</i>
	Self cleaning water filter <i>Filtro acqua autopulente</i>		Cartridge for water filter <i>Cartuccia per filtro acqua</i>



# FDX Hot Cube



## GENERAL FEATURES

- Honda GX series engine (petrol models) or Yanmar L100N engine (Diesel model)
- **Electrical starting-up**
- No engine-oil safety device (oil-alert)
- **Automatic decelerator to reduce the number of revs in the bypass phase**
- **Gearbox (with 1560 rpm pump)**
- Big water filter at pump inlet
- Fuel tank with level float and fill up filter
- Professional pressure-release unloader valve
- Double coil vertical boiler with stainless steel outer casing
- Constant water temperature
- Flow-switch operated burner
- Safety valve
- Boiler thermal protection



## CARATTERISTICHE GENERALI

- Motore Honda Serie GX (modelli a benzina) o Yanmar L100 (modello Diesel)
- **Avviamento elettrico**
- Dispositivo di Sicurezza mancanza olio motore
- **Deceleratore automatico per la riduzione del numero di giri in fase di by-pass (su motori benzina)**
- **Riduttore di giri (con pompa a 1560 rpm)**
- Filtro acqua di grande dimensione in ingresso pompa
- Serbatoio gasolio con galleggiante livello e filtro di riempimento
- Valvola regolazione pressione professionale a rilascio pressione
- Caldaia verticale con serpentina a doppia spirale
- Basso pendolamento temperatura impostata
- Bruciatore azionato da Flussostato
- Valvola di sicurezza
- Protezione termica della caldaia
- Uso professionale continuo

- FW2 pumps with 3 integral ceramic pistons and brass pump head
- Pompe FW2 con 3 pistoni in ceramica e testata in ottone

- Central bar for vertical lifting
- Barra centrale per sollevamento verticale macchina

- Water pumped from tank with filter and float, anti-scale dispenser with pump and 2.5 l capacity tank
- Aspirazione acqua da tanica con filtro e galleggiante, dosatore anticalcare con pompa e serbatoio da 2,5 lt

- High performance stainless steel boiler
- Caldaia ad elevato rendimento realizzata in acciaio inox 304



**CAGE**

**TRAILER**

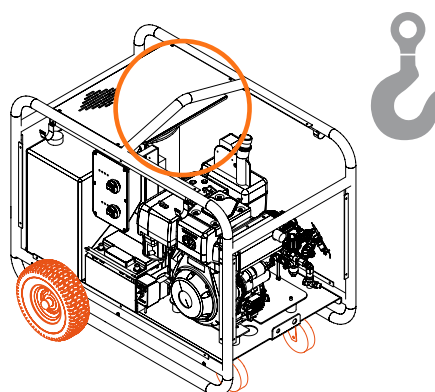
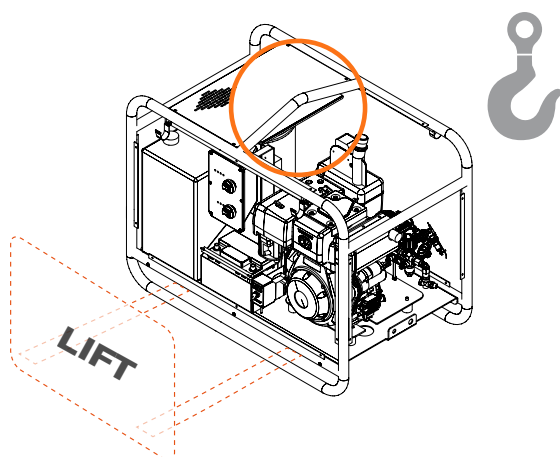

CODE CODICE	MODELS MODELLI	Pressure		Flow	Temperature	Power	Capacity	Weight	Weight	Dimensions
		bar	MPa	l/h	°C	CV	l	kg/h	kg	(L x W x H) cm
9058 0501 *	FDX Hot Cube 16/200 D (L 100 N + FW2)	200	20,0	960	140	11	30	6,3	230	120 x 80 x 95
9058 0502 *	FDX Hot Cube 16/200 B (GX 390 + FW2)	200	20,0	960	140	13	30	6,3	200	120 x 80 x 95
9058 0503 *	FDX Hot Cube 21/160 D (L 100 N + FW2)	160	16,0	1260	140	11	30	7,9	230	120 x 80 x 95
9058 0504 *	FDX Hot Cube 21/160 B (GX 390 + FW2)	160	16,0	1260	140	13	30	7,9	200	120 x 80 x 95

\* Code for Trailer Version / Codice per Versione Trailer

**STANDARD ACCESSORIES › DOTAZIONE STANDARD**

	GH 351 gun with Swivel (n.2 o-ring) <i>Pistola GH 351 con Swivel (n.2 o-ring)</i>		Double barrel lance, without nozzles <i>Lancia a canna doppia senza ugelli</i>
	Fan shape nozzle 25°, 1/4" MEG connection <i>Ugello con getto a lama 25° attacco 1/4" MEG</i>		Detergent nozzle for double barrel lance, 1/4" MEG connection <i>Ugello detergente per lancia canna doppia, attacco 1/4" MEG</i>
	10 m rubber delivery hose kit <i>Kit tubo gomma mandata 10 m</i>		Brass inlet water filter <i>Filtro aspirazione acqua in ottone</i>
	RPM deceleration kit <i>Kit deceleratore di giri motore</i>		Flame control kit <i>Kit comando controllo fiamma</i>

X SPECIAL



# FDX WB



## GENERAL FEATURES

- 120 l polyethylene tank
- Painted steel frame
- Wheels with puncture-proof tyres
- Honda GX160 and Loncin G200F engines
- Comet LWD-K and BWD-K self-priming triplex pumps, with ceramic pistons and brass pump head
- Professional unloader valve
- Double suction filter (suction strainer inside tank and readily serviceable external filter at pump inlet)
- Regulated low-pressure detergent suction
- Overheating thermostatic valve
- GH301 spray gun with swivel
- Hose reel with 15m G1/4 hose
- Semi-professional use



## CARATTERISTICHE GENERALI

- Cisterna 120 LT in polietilene
- Telaio in acciaio verniciato
- Ruote con gomma anti-foratura
- Motori Honda GX160 e Loncin G200F
- Pompe Comet LWD-K e BWD-K, triplex autoadescanti, a pistoni in ceramica e testata in ottone
- Valvola di regolazione professionale
- Doppio filtro in aspirazione (cestina di fondo all'interno della cisterna e filtro esterno ispezionabile in ingresso pompa)
- Aspirazione detergente in bassa pressione con regolazione
- Valvola termostatica di protezione da sovratemperatura
- Pistola GH301 con swivel
- Avvolgitubo con 15mt tubo G1/4
- Uso semiprofessionale

- Readily serviceable external suction filter
- *Filtro aspirazione esterno ispezionabile*



- 15 m hose reel
- *Avvolgitubo 15 m*



- Comet Triplex pump, ceramic pistons and brass head
- *Pompa triplex Comet con testata in ottone*



CODE CODICE	MODELS MODELLI						
		bar	MPa	l/h	CV	kg	(L x W x H) cm
9020 0801	FDX WB 8/160 LWD-K Honda GX 160	160	16,0	480	5,5	70	120 x 80 x 110
9020 0802	FDX WB 8/160 BWD-K Loncin G 200 F	160	16,0	480	6,0	70	120 x 80 x 110

**STANDARD ACCESSORIES › DOTAZIONE STANDARD**

	GH 351 gun with Swivel <i>Pistola GH 351 con Swivel</i>		Bent lance with detergent head, without nozzle <i>Lancia angolata con testina detergente, senza ugello</i>
	Fan shape nozzle 25°, 1/4" MEG connection <i>Ugello con getto a lama 25°, attacco 1/4" MEG</i>		15 m hose reel <i>Avvolgitubo 15 m</i>
	Thermostatic Valve (optimal functioning when supplied with tap water pressure) <i>Valvola termostatica (funzionamento ottimale solo se alimentata in pressione)</i>		

X SPECIAL



PTO



PREMIUM



## GENERAL FEATURES

- Also available with compact closing frame (71x85x15 cm)
- RW pumps with 1450 rpm gearbox kit
- With TWN pump for direct application
- Water suction from external tank option (self-priming pumps)
- Professional pressure unloader valve
- Shield for cardan shaft
- Readily serviceable brass water suction filter
- Pressure Gauge



## CARATTERISTICHE GENERALI

- Disponibile anche completa di telaio richiudibile e di ridotte dimensioni (71x85x15 cm)
- Pompe RW con moltiplicatore a 1450 giri/min
- Con pompa TWN per applicazione diretta
- Possibilità di aspirare acqua da serbatoio esterno (pompe autoadescanti)
- Valvola di regolazione pressione professionale
- Protezione Albero Cardanico
- Filtro aspirazione acqua in ottone, facilmente ispezionabile
- Manometro di pressione
- Uso professionale



- 1 Coupling for tractor's 3rd linkage point, diam. 19 - 25 mm
- 2 22 mm diameter pins for 3-point hitch
- 3 Gearbox kit for 1450 rpm pumps (RW)

- 1 Attacco al terzo punto trattore diam. 19 - 25 mm
- 2 Pini diametro 22 mm per attacco ai bracci del sollevatore
- 3 Moltiplicatore per pompe a 1450 giri/min (RW)



- Comet TWN and RW Premium pumps with 3 integral ceramic pistons and brass pump head. Two oil sight glasses
- Pompe Comet TWN e RW Premium con 3 pistoni in ceramica integrale con testata in ottone. Doppio visore livello olio



CODE CODICE	MODELS MODELLI				
		bar	MPa	l/h	CV
<b>PTO Premium with frame - con telaio</b>					
9045 0014 *	PTO 21/200 - RW	200	20,0	1260	10,5
9045 0003 ●	PTO 23/200 - TWN	200	20,0	1380	11,3
9045 0005 ●	PTO 30/170 - TWN	170	17,0	1800	12,3
<b>PTO Premium without frame - senza telaio</b>					
9045 0017 *	PTO 15/150 - RW	150	15,0	900	6,0
9045 0016 *	PTO 21/200 - RW	200	20,0	1260	10,5
9045 0008 ●	PTO 23/200 - TWN	200	20,0	1380	11,3
9045 0010 ●	PTO 30/170 - TWN	170	17,0	1800	12,3

- \* with gearbox kit (540 rpm PTO) - con moltiplicatore (PTO 540 giri/min)
- without gearbox kit (1000 rpm PTO) - senza moltiplicatore (PTO 1000 giri/min)

**STANDARD ACCESSORIES › DOTAZIONE STANDARD**

	Gun GH 350 with Swivel, n. 2 o-ring <i>Pistola GH 350 con swivel, n. 2 o-ring</i>		Bent double barrel lance, without nozzles <i>Lancia a canna doppia angolata, senza ugelli</i>
	Detergent nozzle for double barrel lance, 1/4" MEG connection <i>Ugello detergente per lancia canna doppia, attacco 1/4" MEG</i>		Fan shape nozzle 25°, 1/4" MEG connection <i>Ugello con getto a lama 25° attacco 1/4" MEG</i>
	SAE 100, 10 m rubber delivery hose kit <i>Kit tubo gomma mandata SAE 100 - 10 m</i>		Water suction filter <i>Filtro aspirazione acqua</i>



# TRAPPER 2

## 120 - 130 GOLD



### GENERAL FEATURES

- Comet electrical pump with three axial pistons arranged vertically with pump at the bottom and an all-metal construction without any plastic used for the structural components.
- Head in brass (**Gold version only**) or aluminium
- Fuel tank with level indicator
- **EASY-START** device
- **TotalStop** device
- **Combustion head with transparent flame viewer**
- Delayed burner start
- Safety valve
- Boiler thermal protection
- Switch 0 - 1 - 2 (stop - cold water - hot water)
- Motor thermal cut-out



### CARATTERISTICHE GENERALI

- **Elettropompa Comet a tre pistoni assiali disposta in verticale con pompa in basso e costruzione interamente in metallo, senza materiale plastico nei componenti strutturali.**
- Testa pompa in ottone (**solo versione Gold**) o alluminio
- Serbatoio gasolio con spia di livello
- Dispositivo **EASY-START**
- Dispositivo **TotalStop**
- **Testa di combustione con oblò controllo fiamma**
- Partenza ritardata del bruciatore
- Valvola di sicurezza
- Protezione termica della caldaia
- Interruttore 0 - 1 - 2 (stop - acqua fredda - acqua calda)
- Protezione termica del motore
- **Uso domestico**

- Big rubber wheels
- *Ruote di grandi dimensioni*



- Small, powerful and easy to use
- *Piccola, potente e semplice da usare*



- Safety valve
- *Valvola di sicurezza*



- Combustion head with transparent flame viewer
- *Testa di combustione con oblò controllo fiamma*



CODE CODICE	MODELS MODELLI	Ph		V		Hz		bar		MPa		l/h		kW		°C		l		kg/h		kg		(L x W x H) cm	
9049 0002	TRAPPER 2 120	1	230	50	120	12,0	450	2,0	90	25	2,45	55	68 x 50 x 80												
9049 0502	TRAPPER 2 130 GOLD	1	230	50	130	13,0	450	2,2	90	25	2,45	55	68 x 50 x 80												



**STANDARD ACCESSORIES › DOTAZIONE STANDARD**

<p>Gun GH 251 with protection <i>Pistola GH 251 con protezione</i></p>	<p>Bent lance with protection, without nozzle <i>Lancia angolata con protezione, senza ugello</i></p>
<p>Fan shape nozzle 25°, 1/4" MEG connection <i>Ugello con getto a lama 25° attacco 1/4" MEG</i></p>	<p>SAE 100, 8 m rubber delivery hose kit <i>Kit tubo gomma mandata SAE 100 - 8 m</i></p>
<p>Foam lance <i>Lancia schiumogena</i></p>	

RED SERIES COMMERCIAL



# SCOUT



## 135 - 150



### GENERAL FEATURES

- **Comet electrical pump with three axial pistons arranged horizontally with pump at the bottom and an all-metal construction without any plastic used for the structural components and brass pump head**
- Pressure gauge
- Built-in fuel and detergent tanks
- Direct low-pressure suction of water with detergent
- **EASY-START** device
- **TotalStop** device
- Delayed burner start
- Safety valve
- Amperometric motor protection
- **Temperature setting thermostat**



### CARATTERISTICHE GENERALI

- **Elettropompa Comet a tre pistoni assiali disposta in orizzontale con pompa in basso e costruzione interamente in metallo, senza materiale plastico nei componenti strutturali e testata in ottone**
- Manometro pressione
- Serbatoio gasolio e detergente integrati
- Aspirazione acqua diretta con detergente in bassa pressione
- Dispositivo **EASY-START**
- Dispositivo **TotalStop**
- Partenza ritardata del bruciatore
- Valvola di sicurezza
- Protezione amperometrica del motore
- **Termostato di regolazione temperatura**
- Uso semiprofessionale

- Big rubber wheels
- Ruote di grandi dimensioni



- Practical lance and gun storage
- Pratico alloggiamento della pistola e della lancia



Hose reel with 10 m high-pressure hose  
(for EXTRA models only)  
Avvolgitubo con tubo alta pressione in gomma 10 m.  
(solo per modelli EXTRA)



CODE CODICE	MODELS MODELLI													
		Ph	V	Hz	bar	MPa	l/h	kW	°C	l	kg/h	l	kg	(L x W x H) cm
9044 0001	SCOUT CLASSIC 150	1	230	50	150	15,0	540	2,7	90	15	3,11	4,5	85	89 x 50 x 82
9044 0003	SCOUT CLASSIC 135	1	230	50	135	13,5	600	2,7	90	15	3,11	4,5	85	89 x 50 x 82
9044 0002	SCOUT EXTRA 150	1	230	50	150	15,0	540	2,7	90	15	3,11	4,5	85	89 x 50 x 82
9044 0004	SCOUT EXTRA 135	1	230	50	135	13,5	600	2,7	90	15	3,11	4,5	85	89 x 50 x 82



STANDARD ACCESSORIES > DOTAZIONE STANDARD

CLASSIC		EXTRA	
	Gun GC 251 with protection <i>Pistola GC 251 con protezione</i>		Bent lance with detergent head, without nozzle <i>Lancia angolata con testina detergente, senza ugello</i>
	Fan shape nozzle 15°, 1/4" MEG connection <i>Ugello con getto a lama 15° attacco 1/4" MEG</i>		SAE 100, 8 m rubber delivery hose kit <i>Kit tubo gomma mandata SAE 100 - 8 m</i>
	SAE 100, 10 m rubber delivery hose kit <i>Kit tubo gomma mandata SAE 100 - 10 m</i>		



# KD 2



## GENERAL FEATURES

- Fuel tank with level floater and fill up filter
- Regulated low-pressure detergent suction
- Direct water suction with readily serviceable suction filter
- Pressure regulation
- **TotalStop** device
- Pressure gauge
- **EASY-START** device
- Delayed burner start
- Safety valve
- Contactor
- Motor protected with a thermal relay
- Rotary On-Off switch
- **Temperature setting thermostat**
- "No fuel" indicator



## CARATTERISTICHE GENERALI

- Serbatoio gasolio con galleggiante livello e filtro di riempimento
- Aspirazione detergente in bassa pressione con regolazione
- Aspirazione acqua diretta con filtro aspirazione ispezionabile
- Regolazione della pressione
- Dispositivo **TotalStop**
- Manometro pressione
- Dispositivo **EASY-START**
- Partenza ritardata del bruciatore
- Valvola di sicurezza
- Teleruttore
- Protezione del motore con relè termico
- Interruttore Rotativo per accensione
- **Termostato di regolazione temperatura**
- Spia "Mancanza gasolio"
- Uso semiprofessionale gravoso

- Big rubber wheels (250 mm ø)
- Ruote di grandi dimensioni (ø 250 mm)

- Motor pump unit with Comet AXR pump, unloader valve and brass pump head
- Gruppo motopompa con pompa Comet AXR e valvola regolazione, con testata in ottone



CODE CODICE	MODEL MODELLO													
		Ph	V	Hz	bar	MPa	l/h	kW	°C	l	kg/h	l	kg	(L x W x H) cm
9034 0100	KD 2 10/140 M	1	230	50	140	14,0	600	3,0	110	13	3,3	13	90	90 x 71 x 86



**STANDARD ACCESSORIES › DOTAZIONE STANDARD**

 <p>Gun GH 251 with protection <i>Pistola GH 251 con protezione</i></p>	 <p>Bent lance with detergent head, without nozzle <i>Lancia angolata con testina detergente, senza ugello</i></p>
 <p>Fan shape nozzle 15°, 1/4" MEG connection <i>Ugello con getto a lama 15° attacco 1/4" MEG</i></p>	 <p>SAE 100, 10 m rubber delivery hose kit <i>Kit tubo gomma mandata SAE 100 - 10 m</i></p>



# KM BASIC



## GENERAL FEATURES

- 18-litre capacity fuel tank with level float and fill up filter
- Low pressure detergent suction with adjustment of the quantity from an inside tank; possibility of using an external detergent tank
- Direct water suction with readily serviceable suction cartridge filter
- Motor pump unit with Comet GXR/AXR pump with brass pump manifold and professional 2-pole unloader valve (2800 rpm)
- **EASY-START** on 1-230 models
- **TotalStop**
- Delayed burner start
- Safety valve
- Rotary On-Off switch
- Contactor and motor protection with thermal relay
- **Temperature setting thermostat**
- "No fuel" indicator



## CARATTERISTICHE GENERALI

- *Serbatoio gasolio di capacità 18 litri, con galleggiante di livello e filtro di riempimento*
- *Aspirazione detergente in bassa pressione con regolazione della quantità da serbatoio interno, possibilità di aspirare da tanica esterna*
- *Aspirazione acqua diretta con filtro aspirazione a cartuccia ispezionabile*
- *Gruppo motopompa con pompa Comet GXR / AXR con testata in ottone e valvola regolazione professionale 2 poli (2800 giri)*
- **EASY-START** su modelli 1-230
- **TotalStop**
- *Partenza ritardata del bruciatore*
- *Valvola di sicurezza*
- *Interruttore Rotativo per accensione*
- *Teleruttore e protezione del motore con relè termico*
- **Termostato di regolazione temperatura**
- *Spia "Mancanza gasolio"*
- *Uso semiprofessionale gravoso*



- Separate boiler fan unit
- Gruppo ventilazione caldaia indipendente

- Door for adjusting pump pressure and for inspecting and cleaning water filter
- Sportello per regolazione della pressione pompa e per ispezione e pulizia del filtro acqua

- Cover for :
  - a. adjustment and fill detergent tank, with external tank suction system
  - b. access to the crossbar for lifting
  - c. Casing lock screw
- Coperchio per :
  - a. regolazione e riempimento serbatoio detergente, con possibilità di aspirazione da serbatoio esterno
  - b. accesso al gancio di sollevamento della idropulitrice
  - c. vite di bloccaggio carenatura

- Hose reel with 15 m high-pressure rubber hose
- Avvolgitubo con 15 mt tubo gomma alta pressione (optional)



- Access to all inner parts, casing comes off in one piece
- Accesso a tutte le parti interne rimuovendo la Carenatura in unico pezzo

- Comet AXR and GXR pump with axial ceramic pistons and brass head
- Pompa Comet AXR e GXR a pistoni assiali in ceramica e testata in ottone

- 2 swivel wheels in addition to the two fixed wheels
- 2 ruote girevoli in aggiunta alle due ruote fisse

- Practical and safe lance supports
- Pratici e sicuri supporti lancia



CODE CODICE	MODELS MODELLI	Electrical		Pressure		Flow	Power	Temperature	Capacity	Weight	Dimensions				
		Ph	V	Hz	bar	MPa	l/h	CV	kW	°C	l	kg/h	l	kg	(L x W x H) cm
9060 0001	KM Basic 3.10 10/140	1	230	50	140	14	600	3,0	3,0	110	18	4,4	3,5	115	95 x 62 x 85
9060 0002	KM Basic 5.12 12/180	3	400	50	180	18	720	5,0	5,0	110	18	4,4	3,5	115	95 x 62 x 85

**STANDARD ACCESSORIES › DOTAZIONE STANDARD**

<p>Gun GH 251 with protection Pistola GH 251 con protezione</p>	<p>Bent lance with detergent head, without nozzle Lancia angolata con testina detergente, senza ugello</p>
<p>Fan shape nozzle 15°, 1/4" MEG connection Ugello con getto a lama 15° attacco 1/4" MEG</p>	<p>SAE 100, 10 m rubber delivery hose kit Kit tubo gomma mandata SAE 100 - 10 m</p>



# KM CLASSIC



- 2 swivel wheels in addition to the two fixed wheels
- 2 ruote girevoli in aggiunta alle due ruote fisse



- Practical and safe lance supports
- Pratici e sicuri supporti lancia



## GENERAL FEATURES

- 18-litre capacity fuel tank with level float and fill up filter
- Low pressure detergent suction with adjustment of the quantity from an inside tank; possibility of using an external detergent tank
- Direct water suction with readily serviceable suction cartridge filter
- 4-pole motor (1400 rpm) with Comet LW-K pumps with brass pump manifold
- FW2 pump with flanged valve on 8.15
- Timed **TotalStop**
- **EASY-START** on 1-230 models
- Delayed burner start
- Professional safety valve
- Boiler thermal protection
- Rotary On-Off switch
- Contactor and motor protection with amperometric control
- Temperature setting thermostat
- "No fuel" indicator
- "Machine switched on" indicator
- "Phase control" indicator



## CARATTERISTICHE GENERALI

- Serbatoio gasolio di capacità 18 litri, con galleggiante di livello e filtro di riempimento
- Aspirazione detergente in bassa pressione con regolazione della quantità da serbatoio interno, possibilità di aspirare da tanica esterna
- Aspirazione acqua diretta con filtro aspirazione a cartuccia ispezionabile
- Motore a 4 poli (1400 giri/min) con pompe Comet LW-K con testata in ottone
- Pompa FW2 con valvola flangiata su 8.15
- **TotalStop** temporizzato
- **EASY-START** su modelli 1-230
- Partenza ritardata del bruciatore
- Valvola di sicurezza professionale
- Protezione termica della caldaia
- Interruttore Rotativo per accensione
- Teleruttore e protezione del motore con controllo amperometrico
- Termostato di regolazione temperatura
- Spia "Mancanza gasolio"
- Spia "Macchina sottotensione"
- Spia "Controllo fase"
- Uso professionale continuo

- Separate boiler fan unit
- Gruppo ventilazione caldaia indipendente

- ON REQUEST / A RICHIESTA**
- Water tank with anti-scale device
  - Vaschetta acqua con dispositivo e serbatoio anticalcare

- Door for adjusting pump pressure and for inspecting and cleaning water filter
- Sportello per regolazione della pressione pompa e per ispezione e pulizia del filtro acqua

- Cover for :
  - a. adjustment and fill detergent tank, with external tank suction system
  - b. access to the crossbar for lifting
  - c. Casing lock screw
- Coperchio per :
  - a. regolazione e riempimento serbatoio detergente, con possibilità di aspirazione da serbatoio esterno
  - b. accesso al gancio di sollevamento della idropulitrice
  - c. vite di bloccaggio carenatura



- Hose reel with 15 m high-pressure rubber hose
- Avvolgitubo con 15 mt tubo gomma alta pressione (optional)

- Access to all inner parts, casing comes off in one piece
- Accesso a tutte le parti interne rimuovendo la Carenatura in unico pezzo

- Front bumper
- Paraurti anteriore

- Comet LW-K, ZW and FW2, Triplex pump, ceramic pistons and brass head
- Pompa Comet LW-K, ZW e FW2, triplex, pistoni in ceramica e testata in ottone



CODE CODICE	MODELS MODELLI	Electrical		Pressure		Flow	Power	Power	Temperature	Capacity	Weight	Dimensions				
		Ph	V	Hz	bar								MPa	l/h	CV	kW
9060 0301	KM Classic 3.11 11/120	1	230	50	120	12	660	3,0	3,0	110	18	4,4	3,5	120	95 x 62 x 85	
9060 0302	KM Classic 5.13 13/180	3	400	50	180	18	780	5,5	4,8	110	18	4,6	3,5	120	95 x 62 x 85	
9060 0303	KM Classic 5.15 15/160	3	400	50	160	16	900	5,5	4,8	110	18	5,5	3,5	120	95 x 62 x 85	
9060 0305	KM Classic 8.15 15/200	3	400	50	200	20	900	7,5	7,0	110	18	5,7	3,5	125	95 x 62 x 85	
<b>With a water tank and anti-scale tank - Con vaschetta acqua e cisterna anticalcare</b>																
9060 0351	KM Classic 3.11 11/120	1	230	50	120	12	660	3,0	3,0	110	18	4,4	3,5	120	95 x 62 x 85	
9060 0352	KM Classic 5.13 13/180	3	400	50	180	18	780	5,5	4,8	110	18	4,6	3,5	120	95 x 62 x 85	
9060 0353	KM Classic 5.15 15/160	3	400	50	160	16	900	5,5	4,8	110	18	5,5	3,5	120	95 x 62 x 85	
9060 0355	KM Classic 8.15 15/200	3	400	50	200	20	900	7,5	7,0	110	18	5,7	3,5	125	95 x 62 x 85	

**STANDARD ACCESSORIES › DOTAZIONE STANDARD**

<p>Gun GH 301 with Swivel Pistola GH 301 con Swivel</p>	<p>Bent lance with detergent head, without nozzle Lancia angolata con testina detergente, senza ugello</p>
<p>Fan shape nozzle 25°, 1/4" MEG connection Ugello con getto a lama 25° attacco 1/4" MEG</p>	<p>SAE 100, 10 m rubber delivery hose kit Kit tubo gomma mandata SAE 100 - 10 m</p>
<p>Bent lance, with nozzle holder (without nozzle) Lancia angolata, testa portaugello (senza ugello)</p> <p><b>only models with water tank and water softener</b> <b>solo modelli con vaschetta acqua e dispositivo anticalcare</b></p>	



# KM EXTRA



- 2 swivel wheels in addition to the two fixed wheels
- 2 ruote girevoli in aggiunta alle due ruote fisse



- Practical and safe lance supports
- Pratici e sicuri supporti lancia



## GENERAL FEATURES

- 18-litre capacity fuel tank with level float and fill up filter
- High pressure detergent suction with adjustment of the quantity from an inside tank, possibility of using an external detergent tank
- Water suction from a tank with an integrated and readily serviceable suction cartridge filter
- Anti-scale device with pump and tank (2.5 l)
- Professional 4-pole motor (1400 rpm) with Comet ZW pumps and professional unloader valve
- FW2 pump on 8.15 model
- Timed **TotalStop**
- **General stop (when the machine is not used for a long time)**
- **EASY-START** on 1-230 models
- Steam operation
- Flow-switch controlled burner
- Professional safety valve
- Boiler thermal protection
- Electronic temperature setting system with constant water temperature
- Delayed burner start



## CARATTERISTICHE GENERALI

- Serbatoio gasolio di capacità 18 litri, con galleggiante di livello e filtro di riempimento
- Aspirazione detergente in alta pressione con regolazione della quantità da serbatoio interno, possibilità di aspirare da tanica esterna
- Aspirazione acqua da cisterna integrata con filtro aspirazione a cartuccia ispezionabile
- Dispositivo anticalcare con pompa e serbatoio (2,5 lt)
- Motore a 4 poli professionale (1400 giri/min) con pompe Comet ZW e valvola regolazione pressione professionale
- Pompa FW2 su modello 8.15
- **TotalStop** temporizzato
- **Stop generale (in caso di prolungata inattività)**
- **EASY-START** su modelli 1-230
- Funzionamento a vapore
- Bruciatore azionato da Flussostato
- Valvola di sicurezza professionale
- Protezione termica della caldaia
- Sistema elettronico di regolazione della temperatura, con basso pendolamento del valore impostato
- Partenza ritardata del bruciatore
- Uso professionale gravoso

- Separate boiler fan unit
- Gruppo ventilazione caldaia indipendente

- Water tank with anti-scale device
- Vaschetta acqua con dispositivo e serbatoio anticalcare

- Door for adjusting pump pressure and for inspecting and cleaning water filter
- Sportello per regolazione della pressione pompa e per ispezione e pulizia del filtro acqua

- Cover for :
  - adjustment and fill detergent tank, with external tank suction system
  - anti-scale tank filling
  - access to the crossbar for lifting
  - Casing lock screw
- Coperchio per :
  - regolazione e riempimento serbatoio detergente, con possibilità di aspirazione da serbatoio esterno
  - riempimento serbatoio anticalcare
  - accesso al gancio di sollevamento della idropulitrice
  - vite di bloccaggio carenatura



- Hose reel with 15 m high-pressure rubber hose
- Avvolgitubo con 15 mt tubo gomma alta pressione (optional)

- Access to all inner parts, casing comes off in one piece
- Accesso a tutte le parti interne rimuovendo la Carenatura in unico pezzo

- Front bumper
- Paraurti anteriore

- Comet LW-K, ZW and FW2, Triplex pump, ceramic pistons and brass head
- Pompa Comet LW-K, ZW e FW2, triplex, pistoni in ceramica e testata in ottone



CODE CODICE	MODELS MODELLI	Electrical			Pressure		Flow	Power	Power	Temperature	Capacity	Weight	Dimensions		
		Ph	V	Hz	bar	MPa								l/h	CV
9060 0501	KM Extra 3.11 11/120	1	230	50	120	12	660	3,0	3,0	140	18	4,4	3,5	120	95 x 62 x 85
9060 0502	KM Extra 5.13 13/180	3	400	50	180	18	780	5,5	4,8	140	18	4,6	3,5	120	95 x 62 x 85
9060 0503	KM Extra 5.15 15/160	3	400	50	160	16	900	5,5	4,8	140	18	5,5	3,5	120	95 x 62 x 85
9060 0505	KM Extra 8.15 15/200	3	400	50	200	20	900	7,5	7,0	140	18	5,7	3,5	125	95 x 62 x 85

**STANDARD ACCESSORIES › DOTAZIONE STANDARD**

<p>Gun GH 351 with Swivel (n. 2 o-ring) Pistola GH 351 con Swivel (n. 2 o-ring)</p>	<p>Bent lance, with nozzle holder, without nozzle Lancia angolata, testina portaugello, senza ugello</p>
<p>Fan shape nozzle 25°, 1/4" MEG connection Ugello con getto a lama 25° attacco 1/4" MEG</p>	<p>SAE 100, 10 m rubber delivery hose kit Kit tubo gomma mandata SAE 100 - 10 m</p>
<p>Flame control kit Kit comando controllo fiamma</p>	



# KE PREMIUM PLUS



## PREMIUM



### GENERAL FEATURES

- Fuel tank with level floater and fill up filter
- Regulated high-pressure detergent suction **(only models with water tank)**
- Regulated low-pressure detergent suction **(only models without water tank)**
- Readily serviceable suction filter
- Professional 4-pole motor (1400 rpm) with double bearing
- Professional pressure unloader valve with external bypass
- Self Priming pumps
- Timed **TotalStop**
- Pressure gauge
- Safety valve
- Boiler thermal protection
- Delayed burner start
- Low voltage control panel
- Contactor
- Motor protected with a thermal relay
- Rotary On-Off switch
- **Temperature setting thermostat**
- "No fuel" indicator
- "Machine switched on" indicator



### CARATTERISTICHE GENERALI

- Serbatoio gasolio con galleggiante livello e filtro di riempimento
- Aspirazione detergente in alta pressione con regolazione **(solo modelli con tanica acqua)**
- Aspirazione detergente in bassa pressione con regolazione **(solo modelli senza tanica acqua)**
- Filtro aspirazione ispezionabile
- Motore a 4 poli (1400 giri/min) professionale con doppio cuscinetto
- Valvola regolazione pressione professionale con by-pass esterno
- Pompe autoadescanti
- **TotalStop** temporizzato
- Manometro pressione
- Valvola di sicurezza
- Protezione termica della caldaia
- Partenza ritardata del bruciatore
- Quadro comandi in bassa tensione
- Teleruttore
- Protezione del motore con relè termico
- Interruttore Rotativo per accensione
- **Termostato di regolazione temperatura**
- Spia "Mancanza gasolio"
- Spia "Macchina sottotensione"
- Uso gravoso

- Big solid wheels (260 mm ø)
- Ruote piene di grandi dimensioni (ø 260 mm)

- Highly professional motor pump unit with patented coupling between motor with double bearing and the Comet RW Premium pump with 3 integral ceramic pistons and brass pump head. External bypass valve
- Gruppo motopompa altamente professionale con accoppiamento brevettato, tra motore con doppio cuscinetto e pompa Comet RW Premium con 3 pistoni in ceramica integrale con testata in ottone. Valvola by-pass esterno

- Separate boiler fan unit
- Gruppo ventilazione caldaia indipendente



CODE CODICE	MODELS MODELLI	Electrical		Pressure		Flow	Power	Temperature	Consumption	Capacity	Weight	Dimensions			
		Ph	V	Hz	bar	MPa	l/h	CV	kW	°C	l	kg/h	l	kg	(L x W x H) cm
<b>Without a water tank - Senza vaschetta acqua</b>															
9033 0901	KE Premium plus 15/200	3	400	50	200	20,0	900	8,0	7,0	110	13	6,4	13	130	103 x 71 x 86
<b>With an inlet water tank - Con vaschetta acqua entrata</b>															
9033 0902	KE Premium plus 15/200	3	400	50	200	20,0	900	8,0	7,0	110	13	6,4	13	130	103 x 71 x 86
<b>With a water tank and anti-scale tank - Con vaschetta acqua e cisterna anticalcare</b>															
9033 0906	KE Premium plus 15/200	3	400	50	200	20,0	900	8,0	7,0	110	13	6,4	13	130	103 x 71 x 86

**STANDARD ACCESSORIES › DOTAZIONE STANDARD**

Without Water Tank <i>Senza Vaschetta Acqua</i>	With Inlet Water Tank <i>Con Vaschetta Acqua Entrata</i>	With Water Tank and Anti-scale Tank <i>Con Vaschetta Acqua e Cisterna Anticalcare</i>
	Gun GH 351 with Swivel (n. 2 o-ring) <i>Pistola GH 351 con Swivel (n. 2 o-ring)</i>	
		Bent lance with nozzle holder, without nozzle <i>Lancia angolata con testa portaugello, senza ugello</i>
	Fan shape nozzle 25°, 1/4" MEG connection <i>Ugello con getto a lama 25° attacco 1/4" MEG</i>	
	SAE 100, 10 m rubber delivery hose kit <i>Kit tubo gomma mandata SAE 100 - 10 m</i>	



# KF CLASSIC



## PREMIUM

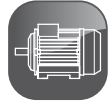

### GENERAL FEATURES

- Fuel tank with level floater and fill up filter
- Regulated high-pressure detergent suction **(only models with water tank)**
- Regulated low-pressure detergent suction **(only models without water tank)**
- Readily serviceable suction filter
- Professional 4-pole motor (1400 rpm)
- Professional pressure unloader valve
- **EASY-START** device (single-phase models only)
- Timed **TotalStop**
- Pressure gauge
- Flow-switch controlled burner
- Safety valve
- Boiler thermal protection
- Delayed burner start
- Low voltage control panel
- Contactor
- Motor protected with thermal relay
- Rotary On-Off switch
- **Temperature setting thermostat**
- "No fuel" indicator
- "Machine switched on" indicator



### CARATTERISTICHE GENERALI

- Serbatoio gasolio con galleggiante livello e filtro di riempimento
- Aspirazione detergente in alta pressione con regolazione **(solo modelli con tanica acqua)**
- Aspirazione detergente in bassa pressione con regolazione **(solo modelli senza tanica acqua)**
- Filtro aspirazione ispezionabile
- Motore a 4 poli professionale (1400 giri/min)
- Valvola regolazione pressione professionale
- Dispositivo **EASY-START** (solo modelli monofase)
- **TotalStop** temporizzato
- Manometro pressione
- Bruciatore azionato da Flussostato
- Valvola di sicurezza
- Protezione termica della caldaia
- Partenza ritardata del bruciatore
- Quadro comandi in bassa tensione
- Teleruttore
- Protezione del motore con relè termico
- Interruttore Rotativo per accensione
- **Termostato di regolazione temperatura**
- Spia "Mancanza gasolio"
- Spia "Macchina sottotensione"
- Uso gravoso



- Door for inspecting and cleaning the water filter
- Sportello ispezione e pulizia filtro acqua

- Separate boiler fan unit
- Gruppo ventilazione caldaia indipendente

- Glove compartment with handy access to check pump oil level
- Vano portaoggetti con pratico accesso controllo livello olio pompa.

- Comet RW Premium pump with 3 integral ceramic pistons and brass pump head. Two oil sight glasses
- Pompa Comet RW Premium con 3 pistoni in ceramica integrale con testata in ottone. Doppio visore livello olio



CODE CODICE	MODELS MODELLI	Electrical			Pressure		Flow	CV	kW	°C	L	kg/h	I	kg	(L x W x H) cm
		Ph	V	Hz	bar	MPa									
<b>Without a water tray - Senza vaschetta acqua</b>															
9051 0001	KF 3.11	1	230	50	110	11,0	660	3,0	3,0	110	19	5,4	16	142	132 x 82 x 96
9051 0002	KF 5.15	3	400	50	150	15,0	900	5,5	4,8	110	19	5,4	16	142	132 x 82 x 96
9051 0301	KF Premium 6.15	3	400	50	160	16,0	900	6,0	5,8	110	19	6,4	16	152	132 x 82 x 96
9051 0302	KF Premium 8.15	3	400	50	200	20,0	900	8,0	7,0	110	19	6,4	16	152	132 x 82 x 96
<b>With a water tray - Con vaschetta acqua</b>															
9051 0007	KF 3.11	1	230	50	110	11,0	660	3,0	3,0	110	19	5,4	16	142	132 x 82 x 96
9051 0006	KF 5.15	3	400	50	150	15,0	900	5,5	4,8	110	19	5,4	16	142	132 x 82 x 96
9051 0309	KF Premium 6.15	3	400	50	160	16,0	900	6,0	5,8	110	19	6,4	16	152	132 x 82 x 96
9051 0308	KF Premium 8.15	3	400	50	200	20,0	900	8,0	7,0	110	19	6,4	16	152	132 x 82 x 96
9051 0306	KF Premium 9.18	3	400	50	200	20,0	1080	9,0	7,6	110	19	6,4	16	158	132 x 82 x 96
9051 0307	KF Premium 9.21	3	400	50	170	17,0	1260	9,0	7,6	110	19	6,4	16	158	132 x 82 x 96
9051 0951	KF Premium 10.18	3	400	50	220	22,0	1080	10,0	9,8	110	19	8,0	16	165	132 x 82 x 96
9051 0952	KF Premium 10.21	3	400	50	210	21,0	1260	10,0	10,3	110	19	8,0	16	165	132 x 82 x 96



**STANDARD ACCESSORIES › DOTAZIONE STANDARD**

Without Water Tank <i>Senza Vaschetta Acqua</i>	With Water Tank <i>Con Vaschetta Acqua</i>
<p>Gun GH 351 with Swivel (n. 2 o-ring) <i>Pistola GH 351 con Swivel (n. 2 o-ring)</i></p>	<p>Bent lance with nozzle holder, without nozzle <i>Lancia angolata con testa portaugello, senza ugello</i></p>
<p>Bent lance with detergent head, without nozzle <i>Lancia angolata con testina detergente, senza ugello</i></p>	<p>Fan shape nozzle 25°, 1/4" MEG connection <i>Ugello con getto a lama 25° attacco 1/4" MEG</i></p>
<p>SAE 100, 10 m rubber delivery hose kit <i>Kit tubo gomma mandata SAE 100 - 10 m</i></p>	



# KF EXTRA



## PREMIUM



### GENERAL FEATURES

- Fuel tank with level floater and fill up filter
- Regulated high-pressure detergent suction
- Readily serviceable suction filter
- Big solid wheels (300 mm ø)
- Anti-scale device with pump and tank (2.5 l)
- Professional 4-pole motor (1400 rpm)
- Professional pressure-release unloader valve
- **EASY-START** device (single-phase models only)
- Timed **TotalStop**
- General stop (when the machine is not used for a long time)
- Double coil vertical boiler
- **Stainless steel outer casing**
- Constant water temperature
- Flow-switch controlled burner
- Safety valve
- Boiler thermal protection
- Delayed burner start



### CARATTERISTICHE GENERALI

- *Serbatoio gasolio con galleggiante livello e filtro di riempimento*
- *Aspirazione detergente in alta pressione con regolazione*
- *Filtro aspirazione ispezionabile*
- *Ruote piene di grandi dimensioni (ø 300 mm)*
- *Dispositivo anticalcare con pompa e serbatoio (2,5 lt)*
- *Motore a 4 poli professionale (1400 giri/min)*
- *Valvola regolazione pressione professionale a rilascio pressione*
- *Dispositivo **EASY-START** (solo modelli monofase)*
- ***TotalStop** temporizzato*
- *Stop generale (in caso di prolungata inattività)*
- *Caldaia verticale con serpentina a doppia spirale*
- ***Corpo esterno caldaia in acciaio inox***
- *Basso pendolamento temperatura impostata*
- *Bruciatore azionato da Flussostato*
- *Valvola di sicurezza*
- *Protezione termica della caldaia*
- *Partenza ritardata del bruciatore*
- *Uso continuo*

- Door for inspecting and cleaning the water filter
- Sportello ispezione e pulizia filtro acqua



- Separate boiler fan unit
- Gruppo ventilazione caldaia indipendente



- Glove compartment with handy access to check pump oil level
- Vano portaoggetti con pratico accesso controllo livello olio pompa.



- Comet RW Premium pump with 3 integral ceramic pistons and brass pump head. Two oil sight glasses
- Pompa Comet RW Premium con 3 pistoni in ceramica integrale con testata in ottone. Doppio visore livello olio



### CONTROL PANEL

- Low voltage controls
- Contactor
- Motor protected with a thermal relay
- Rotary On-Off switch
- Electronic temperature setting
- "No fuel" indicator
- "Machine switched on" indicator
- "General Stop" indicator
- "Motor thermal cut-out triggered" indicator
- "Microleaks alarm" indicator
- "Steam shutdown" indicator
- "Check burner" indicator

### QUADRO COMANDI

- Comandi in bassa tensione
- Teleruttore
- Protezione del motore con relè termico
- Interruttore Rotativo per accensione
- Regolazione elettronica temperatura
- Spia "Mancanza gasolio"
- Spia "Macchina sottotensione"
- Spia "Stop Generale"
- Spia "Intervento termico motore"
- Spia "Allarme microperdite"
- Spia "Stop vapore"
- Spia "Controllo bruciatore"

CODE CODICE	MODELS MODELLI	Electrical			Pressure		Flow l/h	Power CV	Power kW	Temperature °C	Capacity l	Consumption kg/h	Volume l	Weight kg	Dimensions (L x W x H) cm
		Ph	V	Hz	bar	MPa									
9051 0501	KF 3.11	1	230	50	110	11,0	660	3,0	3,0	140	19	5,4	16	144	132 x 82 x 96
9051 0701	KF Premium 6.15	3	400	50	160	16,0	900	6,0	5,8	140	19	6,4	16	144	132 x 82 x 96
9051 0703	KF Premium 8.15	3	400	50	200	20,0	900	8,0	7,0	140	19	6,4	16	154	132 x 82 x 96
9051 0704	KF Premium 9.18	3	400	50	200	20,0	1080	9,0	7,6	140	19	6,4	16	160	132 x 82 x 96
9051 0702	KF Premium 9.21	3	400	50	170	17,0	1260	9,0	7,6	140	19	6,4	16	160	132 x 82 x 96
9051 0901	KF Premium 10.18	3	400	50	220	22,0	1080	10,0	9,8	140	19	8,0	16	165	132 x 82 x 96
9051 0902	KF Premium 10.21	3	400	50	210	21,0	1260	10,0	10,3	140	19	8,0	16	165	132 x 82 x 96

### STANDARD ACCESSORIES › DOTAZIONE STANDARD

	Gun GH 351 with Swivel (n. 2 o-ring) <i>Pistola GH 351 con Swivel (n. 2 o-ring)</i>		Bent lance, with nozzle holder, without nozzle <i>Lancia angolata, testina portaugello, senza ugello</i>
	Fan shape nozzle 25°, 1/4" MEG connection <i>Ugello con getto a lama 25° attacco 1/4" MEG</i>		SAE 100, 10 m rubber delivery hose kit <i>Kit tubo gomma mandata SAE 100 - 10 m</i>
	Flame control kit <i>Kit comando controllo fiamma</i>		

**VACUUM CLEANERS • *ASPIRATORI***

---

## VACUUM CLEANERS • ASPIRATORI

### Cartridge filters • Filtro a cartuccia

- Suitable for dust with a grain size bigger than 5 µm. This does not include dust produced by tools used for honing, grinding or sanding, etc., which are usually fine and are smaller than 5 µm.
- *Adatti per polveri con granulometrie superiori ai 5 µm, sono escluse le polveri generate da utensili per levigazione, smerigliatura, carteggio, ecc., in quanto solitamente generano polveri (fini) inferiori ai 5 µm.*



### Hepa and BIA • cartridge filter Filtro a cartuccia Hepa e BIA

- When working with tools for honing, grinding or sanding, etc., Law Decree 626/94 requires the use of Hepa and BIA filters which are capable of retaining dust particles as small as 0.3 µm (equivalent to a filtration efficiency of 99.97%). As a result, a standard filter is not enough.
- *La norma 626/94 impone, nelle lavorazioni con utensili per levigazione, smerigliatura, carteggio, ecc., l'utilizzo dei filtri Hepa e BIA, in quanto sono in grado di filtrare particelle di polvere fino a 0,3 µm (equivalente ad una percentuale di filtrazione del 99,97%), per questo motivo il filtro standard non basta*



### Polyester filter with ring and filter cage Filtro in poliestere con anello e tendifiltro

- It can be used with the cartridge filter installed or in place of it. By increasing the number of filtration stages the primary filter works more efficiently and requires less frequent cleaning. In this case the polyester fabric filter with ring serves as the first level filter. Using the polyester filter together with the cartridge filter brings the retention capacity of the filter down from 5 µm to 3 µm
- *Può essere utilizzato con il filtro a cartuccia montato o in alternativa ad esso. Aumentando gli stadi di filtrazione il filtro primario lavora meglio e necessita di essere ripulito con minor frequenza in questo modo il panno con anello assume il ruolo di filtro primo livello. Utilizzando il filtro poliestere, insieme al filtro a cartuccia si abbassa il valore da 5 µm fino a 3 µm.*



### Nylon filter with ring and filter cage Filtro in nylon con anello e tendifiltro

- This must always be used with the cartridge filter installed. With certain applications we recommend using it together with the BIA and Hepa cartridge filter rather than the standard one (car body shops, carpentry, marble works, etc.).
- *Deve sempre essere utilizzato con il filtro a cartuccia montato, in particolari settori è consigliabile impiegarlo con il filtro cartuccia Hepa e BIA anzichè quello standard (carrozzerie, falegnamerie, marmorie, ecc.).*



### Sponge filter • Filtro a mousse

- This must be fitted on the float mount (after removing the cartridge filter) every time the unit is to be used to aspirate liquids.
- *Deve essere montato sul portagalleggiante ogni volta che si devono aspirare liquidi (dopo aver rimosso il filtro a cartuccia).*



#### CAUTION

Never suck flammable, explosive, toxic or carcinogenic liquids.

#### ATTENZIONE

Evitare assolutamente l'aspirazione di liquidi infiammabili, esplosivi, tossici e cancerogeni.

**PROFESSIONAL SERIES WITH OUTLET FOR POWER DRIVEN TOOLS - SERIE PROFESSIONALE CON ATTACCO ELETTROUTENSILE**

## AC 18

Aspiracenere



### GENERAL FEATURES - CARATTERISTICHE GENERALI

- Powerful ash vacuuming, complete with flexible metal hose and aluminium nozzle. Clean the filter by pulling a knob on the cover that shakes the filter.
- Potente aspira cenere, completo di tubo flessibile in metallo e bocchetta in alluminio. Pulizia filtro mediante pomello scuotifiltro sul coperchio.

## AS 21

Wet& Dry



### GENERAL FEATURES - CARATTERISTICHE GENERALI

- Compact, designed to take up little room, they are particularly powerful, light, flexible, simple, easy to handle and use.
- Di dimensioni contenute, studiati per essere poco ingombranti, sono particolarmente potenti, leggeri, versatili, semplici, maneggevoli e di facile uso.

## AS 31

Wet& Dry



## AS 22

Wet& Dry



### GENERAL FEATURES - CARATTERISTICHE GENERALI

- The AS 22 Wet & Dry has a dual-turbine motor providing strong suction power that eliminates dust, solids and liquids.
- La potente aspirazione sviluppata dal motore bi-turbina attribuisce una grande capacità nell'aspirazione di polveri, solidi e liquidi.

## AS 35 PRO



### GENERAL FEATURES - CARATTERISTICHE GENERALI

- Complete with a wide range of accessories. Suction by a dual-turbine motor. Particularly suitable for medium-sized areas.
- Corredato da un'ampia gamma di accessori. Aspirazione sviluppata da motore bi-turbina. Particolarmente adatto alle medie superfici.

CARATTERISTICHE TECNICHE - TECHNICAL SPECIFICATIONS		AC 18	AS 21 W&D	AS 31 W&D	AS 22 W&D	AS 35 PRO
CODICE - CODE		9350 0038	9350 0034	9350 0035	9350 0003	9350 0004
Peso • Weight	kg	3,9	5,3	5,5	9	11
Tensione Nominale (Frequenza) • Nominal Voltage (Frequency)	V (Hz)	230 (50-60)	230 (50-60)	230 (50-60)	230 (50-60)	230 (50-60)
Potenza Motore • Motor Power	W	950	1100	1100	1100	1100
Capacità nominale contenitore detriti • Nominal capacity of dirt container	lt	18	20	30	20	35
Contenitore realizzato in • Container made in		ACCIAIO ZINCATO GALVANISED STEEL	ACCIAIO STEEL	ACCIAIO STEEL	PLT	PLT
Depressione max • Maximum Vacuum power	kPa		19	19	21	21
Portata aria efficace • Airflow rate	m³/h		165	165	210	210
Lunghezza cavo alimentazione • Length of the power cable	m	4	5	5	6	6
Tipo motore (Grado di protezione) • Type of motor (Protection level)			by-pass (IPX4)	by-pass (IPX4)	by-pass (IPX4)	by-pass (IPX4)
Classe di isolamento • Insulation class			□	□	□	□
Numero ventole • Number of fans		1	1	1	2	2
SISTEMA FILTRANTE - FILTERING SYSTEM		AC 18	AS 21 W&D	AS 31 W&D	AS 22 W&D	AS 35 PRO
Sacco in carta filtrata o doppio strato • Bag in filtered paper or dual layer			3050 0001	3050 0002	3050 0001	3050 0002
Elemento filtrante a cartuccia • Cartridge filtering element					1002 0142	1002 0142
Filtro-mousse per aspirare sostanze liquide • Sponge filter for vacuuming up liquids			1002 0141	1002 0141	1002 0141	1002 0141
Microfiltro aria in uscita • Microfilter for outlet air					1002 0147	1002 0147
Filtro in polipropilene a canestro • Polypropylene basket filter						1002 0141
Filtro a cartuccia per polveri sottili • Filtering cartridge for fine dust						1002 0141
Filtro con tendifiltro • Filter and filter stretcher		1002 0198				
Cartuccia in fibra di cellulosa • Cartridge filter in cellulose			1002 0048	1002 0048		

## AS 25 PRO-E



- Power driven tool connection
- Collegamento elettroutensile



## AS 50 PRO-E



### GENERAL FEATURES

- The accumulation of processing debris has always been a problem in the workplace, as the operator has to clean up before he can go on to the next stage of the job. The vacuum cleaner can be connected directly to the power-driven tool with a dust collection device. All processing debris is immediately eliminated. Suction is provided by a dual-turbine motor that works automatically in sync with the power tool connected to its electrical outlet. With no dust, debris or slag hindering visibility, the probability of accidents at work or illnesses related to inhaling harmful substances is greatly reduced.

### CARATTERISTICHE GENERALI

- I residui di lavorazione creano disagi nell'esecuzione del lavoro e costringono l'operatore alla pulizia del posto di lavoro per procedere alle operazioni successive. Questo aspiratore può essere direttamente applicato ad elettroutensili predisposti al convogliamento della polvere. Aspira immediatamente tutti i residui di lavorazione. L'aspirazione è sviluppata da motore bi-turbina e funziona automaticamente in simbiosi con l'elettroutensile collegato alla presa a gestione elettrica. In assenza di polvere, i residui o scorie che ostacolano la visibilità, ridurranno la probabilità di incidenti sul lavoro e malattie conseguenti alla respirazione di sostanze nocive.

CARATTERISTICHE TECNICHE - TECHNICAL SPECIFICATIONS		AS 25 PRO-E	AS 50 PRO-E
CODICE - CODE		9350 0010	9350 0006
Peso • Weight	kg	12	18
Tensione Nominale (Frequenza) • Nominal Voltage (Frequency)	V (Hz)	230 (50-60)	230 (50-60)
Potenza Motore • Motor Power	W	1100	1350
Capacità nominale contenitore detriti • Nominal capacity of dirt container	lt	25	50
Contenitore realizzato in • Container in		PLT	ACCIAIO INOX STAINLESS STEEL
Depressione max • Maximum Vacuum power	kPa	21	24
Portata aria efficace • Airflow rate	m <sup>3</sup> /h	210	220
Potenza max disp. alla presa per elettroutensile • Max outlet power for power-driven tools	W	1350	2000
Lunghezza cavo alimentazione • Length of the power cable	m	6	6
Tipo motore (Grado di protezione) • Motor type (Protection level)		by-pass (IPX4)	by-pass (IPX4)
Classe di isolamento • Insulation class		□	□
Numero ventole • Number of fans		2	2
SISTEMA FILTRANTE - FILTERING SYSTEM		AS 25 PRO-E	AS 50 PRO-E
Sacco in carta filtrata o doppio strato • Bag in filtered paper or dual layer		3050 0001	3050 0005
Cartuccia a 3 stadi filtranti • 3-stage filtering cartridge		1002 0145	1002 0143
Filtro-mousse per aspirare sostanze liquide • Sponge filter for vacuuming up liquids		1002 0141	1002 0141
Microfiltro aria in uscita • Microfilter for outlet air		1002 0147	1002 0147
Filtro in polipropilene a canestro • Polypropylene basket filter			1002 0146
Filtro a cartuccia per polveri sottili • Filtering cartridge for fine dust		1002 0162	

**PROFESSIONAL SERIES WITH 1 MOTOR - SERIE PROFESSIONALE A 1 MOTORE**

# AS 50 PRO AS 50 PRO B



### GENERAL FEATURES - CARATTERISTICHE GENERALI

- Powerful, designed and built for demanding jobs. Perfect for big areas such as: workshops, labs, showrooms, hotels, etc. The stainless steel container is suitable for problem-free suction of corrosive liquids.
- *Potenti apparecchi, progettati e costruiti per lavori impegnativi. Adatti alle grandi superfici: officine, laboratori, aree espositive, hotels, etc. Il contenitore in acciaio inox è idoneo per aspirare senza problemi le sostanze liquide corrosive.*

# AS 70 PRO AS 70 PRO B

- Two-suction speed switch
- Interruttore a due velocità d'aspirazione



- Tilting
- Basculante

# AS 37 VIBRA

FOR DUST ONLY  
DO NOT USE TO  
VACUUM LIQUIDS  
**SOLO PER POLVERI**  
DA NON UTILIZZARE  
PER ASPIRARE LIQUIDI



### GENERAL FEATURES - CARATTERISTICHE GENERALI

- Suitable for the suction of processing debris generally. Power-driven tool connection with microprocessor for automatic stop and start. The filter is cleaned automatically thanks to the Intelligent Cleaning Filter vibrating system. A pair of electromechanical vibrators start working only when the filter is dirty.
- *Idoneo nell'aspirazione di residui di lavorazione in genere. Attacco elettroutensili dotato di microprocessore che consente l'avviamento e lo stop automatico. La pulizia del filtro è automatica grazie al sistema vibrante Intelligent Cleaning Filter. Una coppia di vibratori elettromeccanici si attiva solo quando il filtro è sporco.*

CARATTERISTICHE TECNICHE - TECHNICAL SPECIFICATIONS		AS 50 PRO	AS 50 PRO-B	AS 70 PRO	AS 70 PRO-B	AS 37 VIBRA
CODICE - CODE		9350 0005	9350 0007	9350 0008	9350 0009	9350 0032
Peso • Weight	kg	18	24	24	27	13
Tensione Nominale (Frequenza) • Nominal Voltage (Frequency)	V (Hz)	230 (50-60)	230 (50-60)	230 (50-60)	230 (50-60)	230 (50-60)
Potenza Motore • Motor Power	W	1350	1350	1350	1350	1400
Capacità nominale contenitore detriti • Nominal capacity of dirt container	lt	50	50	70	70	37
Contenitore realizzato in • Container made in Stainless Steel		ACCIAIO INOX STAINLESS STEEL	ACCIAIO INOX STAINLESS STEEL	ACCIAIO INOX STAINLESS STEEL	ACCIAIO INOX STAINLESS STEEL	PP
Depressione max • Maximum Vacuum power	kPa	24	24	24	24	24
Portata aria efficace • Airflow rate	m³/h	220	220	220	220	215
Potenza max disp. alla presa per elettroutensile • Max outlet power for power-driven tools	W					2000
Lunghezza cavo alimentazione • Length of the power cable	m	6	6	6	6	8,5
Tipo motore (Grado di protezione) • Motor type (Protection level)		by-pass (IPX4)	by-pass (IPX4)	by-pass (IPX4)	by-pass (IPX4)	by-pass
Classe di isolamento • Insulation class		□	□	□	□	(I)
Numero ventole • Number of fans		2	2	2	2	1
SISTEMA FILTRANTE - FILTERING SYSTEM		AS 50 PRO	AS 50 PRO	AS 50 PRO	AS 50 PRO	AS 37 VIBRA
Sacco in carta filtrata o doppio strato • Bag in filtered paper or dual layer		3050 0005	3050 0004	3050 0005	3050 0004	
Elemento filtrante a cartuccia • Cartridge filtering element		1002 0144	1002 0144	1002 0144	1002 0144	
Filtro a cartuccia Hepa • Hepa cartridge filter						1002 0192
Filtro-mousse per aspirare sostanze liquide • Sponge filter for vacuuming up liquids		1002 0141	1002 0141	1002 0141	1002 0141	
Microfiltro aria in uscita • Microfilter for outlet air		1002 0147	1002 0147	1002 0147	1002 0147	
Filtro in polipropilene a canestro • Polypropylene basket filter		1002 0146	1002 0146	1002 0146	1002 0146	
Filtro a cartuccia per polveri sottili • Filtering cartridge for fine dust		1002 0162	1002 0162	1002 0162	1002 0162	
Filtro nylon • Nylon filter						1002 0193
Filtro in poliestere con tendifiltro • Polyester filter with filter cage						1002 0194
Sacchetto poliestere per polveri fini • Polyester bag for fine dust						3050 0008



# AS 80 PRO Bi Power

- The control panel has an on-off switch for each motor plus a power outlet with switch
- *La plancia di comandi è dotata di interruttore on-off per ciascuno dei due motori e di presa elettrica con relativo interruttore*



## Total filtration Filtrazione totale

### GENERAL FEATURES - CARATTERISTICHE GENERALI

- The Bi-Power cleaners collect all types of solids: from dust to rubble. They are also powerful liquid vacuum cleaners. The healthiness of rooms cleaned with Bi-Power is guaranteed by a triple filtering system able to retain even the smallest particles of dust. The system is made up of a category "G" pre-filter felt basket filter, a cellulose fibre cartridge filter with a large filtering surface and a "Hepa" post air filter for the outgoing air (filtering efficiency greater than 99.97%).
- *I Bi-Power raccolgono solidi di ogni tipo: dalla polvere ai detriti. Sono anche potenti aspiraliquidi. La salubrità degli ambienti aspirati con Bi-Power è assicurata da un triplo sistema filtrante capace di trattenere le particelle di polvere più piccole. Il sistema è costituito da un pre-filtro a canestro in feltro  $\text{G}$  categoria "G", una cartuccia in fibra di cellulosa a grande superficie filtrante, un post-filtro aria "Hepa" in uscita (efficienza filtrante superiore al 99,97%).*

CARATTERISTICHE TECNICHE - TECHNICAL SPECIFICATIONS		AS 80
CODICE - CODE		9350 0011
Peso • Weight	kg	24
Tensione Nominale (Frequenza) • Nominal Voltage (Frequency)	V (Hz)	230 (50-60)
Potenza motore • Motor Power	W	2400
Potenza pompa svuotamento liquidi • Liquid emptying pump power	W	
Capacità nominale contenitore detriti • Nominal capacity of dirt container	lt	80
Contenitore realizzato in • Container made in Stainless Steel		ACCIAIO INOX STAINLESS STEEL
Depressione max • Maximum Vacuum power	kPa	24
Portata aria efficace • Airflow rate	m <sup>3</sup> /h	350
Lunghezza cavo alimentazione elettrica • Length of the power cable	m	6,5
Tipo motore (Grado di protezione) • Motor type (Protection level)		by-pass (IPX4)
Classe di isolamento • Insulation class		□
Numero ventole • Number of fans		2
Presa di servizio • Standard plug	W	800
SISTEMA FILTRANTE - FILTERING SYSTEM		AS 80
		CODICE - CODE
Pre-filtro a canestro in feltro $\text{G}$ cat "G" • Basket pre-filter in felt, $\text{G}$ cat "G"		1002 0154
Elemento filtrante a cartuccia • Cartridge filtering element		1002 0153
Post filtro "US-Hepa" aria in uscita • "US-Hepa" outgoing air post filter		1002 0155
Filtro-mousse per aspirare sostanze liquide • Sponge filter for vacuuming up liquids		1002 0152
Sacco a perdere di raccolta • Disposable collecting bags		3050 0006

# AS 75 F2

## ▶ GENERAL FEATURES - CARATTERISTICHE GENERALI

- Professional vacuum cleaner and liquid cleaner with trolley, handles on the sides, emptying kit to facilitate emptying of the plastic container. Ideal for family businesses, industries and for cleaning large areas.
- *Aspirapolvere ed aspiraliquidi professionale equipaggiato di carrello con maniglie laterali e con kit di svuotamento per facilitare lo svuotamento del fusto in plastica. Ideale per aziende artigiane, industrie e pulizie di grandi superfici.*



# AS 77 B2



## ▶ GENERAL FEATURES - CARATTERISTICHE GENERALI

- Professional vacuum cleaner and liquid cleaner with handle and tilting trolley to make transporting and emptying the plastic container easier. Ideal for family businesses, industries and for cleaning large areas.
- *Aspirapolvere ed aspiraliquidi professionale equipaggiato di maniglione e carrello basculante, per facilitare gli spostamenti e lo svuotamento del fusto in plastica, ideale per aziende artigiane, industrie e pulizie di grandi superfici.*

# AS 78 B3



CARATTERISTICHE TECNICHE - TECHNICAL SPECIFICATIONS		AS 75 F2	AS 77 B2	AS 78 B3
CODICE - CODE		9350 0025	9350 0026	9350 0027
Peso • Weight	kg	21	25	27
Tensione Nominale (Frequenza) • Nominal Voltage (Frequency)	V (Hz)	230 (50-60)	230 (50-60)	230 (50-60)
Potenza Motore • Motor Power	W	2400	2600	3300
N. motori • No. of motors		2	2	3
Capacità nominale contenitore detriti • Nominal capacity of dirt container	lt	77	77	77
Contenitore realizzato in • Container made in		PP	PP	PP
Depressione max • Maximum Vacuum power	kPa	22	24	22
Portata aria efficace • Airflow rate	m <sup>3</sup> /h	340	430	510
Lunghezza cavo alimentazione • Length of the power cable	m	8,5	8,5	8,5
Tipo motore (Grado di protezione) • Motor type (Protection level)		by-pass (IPX4)	by-pass (IPX4)	by-pass (IPX4)
Classe di isolamento • Insulation class		(I)	(I)	(I)
SISTEMA FILTRANTE - FILTERING SYSTEM		AS 75 F2	AS 77 B2	AS 78 B3
	CODICE - CODE	CODICE - CODE	CODICE - CODE	CODICE - CODE
Elemento filtrante a cartuccia poliestere • Polyester cartridge filtering element	1002 0186	1002 0186	1002 0186	
Filtro-mousse per aspirare sostanze liquide • Sponge filter for vacuuming up liquids	1002 0166	1002 0166	1002 0166	
Kit filtro a cartuccia Hepa • Hepa cartridge filter kit	1002 0169	1002 0169	1002 0169	
Filtro in poliestere con anello e tendifiltro • Polyester filter with ring and filter cage	1002 0167	1002 0167	1002 0167	
Sacchetto di carta • Paper bag	3050 0007	3050 0007	3050 0007	
Filtro in poliestere con anello (senza tendifiltro) • Polyester filter with ring (without filter cage)	1002 0184	1002 0184	1002 0184	

PROFESSIONAL SERIES WITH 2 AND 3 MOTORS - SERIE PROFESSIONALE A 2 O 3 MOTORI

# AS 76-2

## ▶ GENERAL FEATURES - CARATTERISTICHE GENERALI

- Extractor model (liquid cleaner) for cleaning armchairs, carpets and rugs, using the right fitting to supply the detergent. A 20-litre capacity tank guarantees good autonomy (water or water mixed with detergent). Use of the detergent is essential while vacuuming up dust is possible with the optional dust kit. Equipped with handle and tilting trolley.
- *Modello estrattore (aspiraliquidi) utilizzabile per la pulizia di poltrone, moquette e tappeti, utilizzando la bocchetta adatta per erogare il detergente, grazie ad un serbatoio da 20 L garantisce una buona autonomia (acqua o acqua mista con detergente). È fondamentale l'utilizzo del detergente, mentre l'aspirazione delle polveri è consentita con il kit polveri, optional. Equipaggiato di maniglione e carrello basculante.*



# AS 81-B3 Metaloil

## ▶ GENERAL FEATURES - CARATTERISTICHE GENERALI

- For vacuuming specific materials such as metal swarfs, wood and glass residues not to mention oils, lubricants and everything else deriving from mechanical manufacturing waste. The suction filter which has a high filtering surface is protected against the direct impact of materials by a cyclone effect barrier.
- *Per l'aspirazione di materiali particolari quali i trucioli di metallo, residui di legno e vetro, nonché oli, lubrificanti e quant'altro derivante dagli scarti della produzione meccanica. Il filtro di aspirazione ad elevata superficie filtrante, è protetto dall'urto diretto dei materiali per mezzo di una barriera che favorisce l'effetto ciclone.*



- "Cyclone" filter protection
- Proteggi filtro "ciclone"

CARATTERISTICHE TECNICHE - TECHNICAL SPECIFICATIONS		AS 76-2	AS 81 METALOIL
CODICE - CODE		9350 0029	9350 0033
Peso • Weight	kg	31	30
Tensione Nominale (Frequenza) • Nominal Voltage (Frequency)	V (Hz)	230 (50-60)	230 (50-60)
Potenza Motore • Motor Power	W	2600	3600
N. motori • No. of motors		2	3
Capacità nominale contenitore detriti • Nominal capacity of dirt container	lt	77	76
Contenitore realizzato in • Container made in Stainless Steel		PP	ACCIAIO INOX STAINLESS STEEL
Depressione max • Maximum Vacuum power	kPa	24	24
Portata aria efficace • Airflow rate	m³/h	430	645
Lunghezza cavo alimentazione • Length of the power cable	m	8,5	8,5
Tipo motore (Grado di protezione) • Motor type (Protection level)		by-pass (IPX4)	by-pass (IPX4)
Classe di isolamento • Insulation class		(I)	(II)
SISTEMA FILTRANTE - FILTERING SYSTEM		AS 76-2	AS 81 METALOIL
		CODICE - CODE	CODICE - CODE
Elemento filtrante a cartuccia poliestere • Polyester cartridge filtering element			1002 0165
Filtro-mousse per aspirare sostanze liquide • Sponge filter for vacuuming up liquids		1002 0166	1002 0166
Proteggi filtro "ciclone" • "Cyclone" filter protection			2416 0147
Kit filtro a cartuccia Hepa • Hepa cartridge filter kit		1002 0169	
Filtro in poliestere con anello e tendifiltro • Polyester filter with ring and filter cage		1002 0167	1002 0167
Sacchetto di carta • Paper bag		3050 0007	
Filtro in poliestere con anello (senza tendifiltro) • Polyester filter with ring (without filter cage)		1002 0184	1002 0184

## NEBULISATION EQUIPMENT • APPARECCHI PER LA NEBULIZZAZIONE

### SPRAY

- Equipment for nebulising low density liquids, detergents and disinfectants.
- Apparecchi per la nebulizzazione di liquidi detergenti e disinfettanti a bassa densità.

**24 Lt  
INOX**



**24 Lt**



**50 Lt**



#### GENERAL FEATURES

- Filled with liquid and loaded with air at 6 bar, they work automatically without having to be connected continuously to compressed air.

#### CARATTERISTICHE GENERALI

- Riempiti di liquido e caricati d'aria a 6 bar, funzionano autonomamente senza bisogno del collegamento continuo all'aria compressa.

	SP 24 SPRAY	SX 24 SPRAY INOX	SP 50 SPRAY
Codice / Code	9360 0001	9360 0003	9360 0005
Capacità / Capacity	24 Lt	24 Lt	50 Lt
Serbatoio / Tank	Acciaio Verniciato Painted Steel	Acciaio INOX Stainless Steel	Acciaio Verniciato Painted Steel
Valvola di Sicurezza Safety Valve	8 bar -MPa 0,8	8 bar - MPa 0,8	8 bar - MPa 0,8
Kit pistola-lancia Gun Lance kit	600 mm	600 mm INOX	900 mm
Tubo / Hose	6 m - RILSAN	6 m - RILSAN	6 m - RILSAN
Ugelli / Nozzles	No. 1 (Ottone - Brass)	No. 1 (Ottone - Brass)	No. 1 (Ottone - Brass)
Manometro / Gauge	SI / YES	SI / YES	SI / YES
Indicatore Livello Level viewer	SI / YES	SI / YES	SI / YES

## NEBULISATION EQUIPMENT - APPARECCHI PER LA NEBULIZZAZIONE

## FOAM

- Equipment for nebulising liquids and detergents with a solution foaming device.
- Apparecchi per la nebulizzazione di liquidi detergenti con dispositivo soluzione schiumogena.

24 Lt  
INOX

24 Lt



50 Lt

 GENERAL FEATURES

- Filled with liquid and loaded with air at 6 bar they need to be connected continuously to compressed air.

 CARATTERISTICHE GENERALI

- Riempiti di liquido e caricati d'aria a 6 bar, necessitano del collegamento continuo all'aria compressa.

	SP 24 FOAM	SX 24 FOAM INOX	SP 50 FOAM
Codice / Code	9360 0002	9360 0004	9360 0006
Capacità / Capacity	24 Lt	24 Lt	50 Lt
Serbatoio / Tank	Acciaio Verniciato Painted Steel	Acciaio INOX Stainless Steel	Acciaio Verniciato Painted Steel
Valvola di Sicurezza Safety Valve	8 bar - MPa 0,8	8 bar - MPa 0,8	8 bar - MPa 0,8
Kit pistola-lancia Gun Lance kit	600 mm	600 mm INOX	900 mm
Tubo / Hose	10 m - PVC	10 m - PVC	10 m - PVC
Ugelli / Nozzles	No. 4 (Ottone - Brass)	No. 4 (Ottone - Brass)	No. 4 (Ottone - Brass)
Manometro / Gauge	SI / YES	SI / YES	SI / YES
Indicatore Livello Level viewer	SI / YES	SI / YES	SI / YES

DETERGENTI · SOLO PER IL MERCATO ITALIANO · ONLY FOR ITALIAN MARKET

# HAND NEUTRO



Autovetture e veicoli industriali



Motori



Edilizia



Macchinari e attrezzature industriali



Statue, fontane, restauro



## CARATTERISTICHE GENERALI

- *Usso Hobbystico*
- *Hand Neutro è un detergente neutro, costituito da una miscela di tensioattivi anionici ad alto potere lavante.*
- *È adatto alle pulizie manuali di tutte le superfici lavabili, in particolare facilita l'eliminazione di ogni tipo di sporco, anche il più tenace, dalle superfici delle autovetture.*
- *Negli impianti di lavaggio automatico, viene usato per un ulteriore ripasso manuale delle zone più sporche.*

## CARATTERISTICHE TECNICHE

- *Hand neutro si usa solitamente diluito in acqua in rapporto da 1:100 a 2:100 (1-2%) a seconda dello sporco. Quando utilizzato con idropulitrice, diluire al 4:100 a 5:100 (4-5%).*
- PH 6.0
- Biodegradabilità 100%
- Confezioni:  
It 1x12 **0609 0007**  
It 5x4 **0609 0008**  
It 10 **0609 0009**

# BASIC AUTO



Autovetture e veicoli industriali



Motori



Edilizia



Veicoli e attrezzature agricole



Macchinari e attrezzature industriali



## CARATTERISTICHE GENERALI

- *Basic Auto è un detergente liquido alcalino, specifico per il lavaggio degli autoveicoli con idropultrici ad acqua calda o acqua fredda.*
- *Ottimo per la pulizia di macchinari ed attrezzature agricole ed industriali.*

## CARATTERISTICHE TECNICHE

- *Basic Auto si usa solitamente diluito in acqua in rapporto da 3:100 a 5:100 (3-5%) per utilizzo manuale o con nebulizzatori.*
- *Quando utilizzato con idropultrice, diluire al 5:100 a 6:100 (5-6%).*
- PH 6.0
- Biodegradabilità 90%
- Confezioni:  
It 1x12 **0609 0010**  
It 5x4 **0609 0011**  
It 10 **0609 0012**

# ECO MOTO



Autovetture e veicoli industriali



Motori



Edilizia



Veicoli e attrezzature agricole



Moto



Statue, fontane, restauro



## CARATTERISTICHE GENERALI

- *Eco Moto è un detergente universale idoneo per la pulizia di ogni tipo di superficie, specifico per il lavaggio di motori, automezzi e attrezzature con particolari di alluminio e di leghe leggere.*
- *Ottimo per la pulizia di moto e biciclette, per la pulizia di piazzali e pavimenti industriali, idoneo al lavaggio delle tende.*

## CARATTERISTICHE TECNICHE

- *Eco Moto si usa solitamente diluito in acqua in rapporto da 2:100 a 20:100 (2-20%) 2-4% per superfici dure con sporco grasso non penetrato, 2-3% per motocicli e biciclette con telai in alluminio, 5-6% per cisterne ed autocarri con particolari in alluminio, 10-20% per motori di auto, camion e barche.*
- *Quando utilizzato con idropultrice, diluire del 10-20%.*
- PH 12.0
- Biodegradabilità 90%
- Confezioni:  
It 1x12 **0609 0013**  
It 5x4 **0609 0014**  
It 10 **0609 0015**

# TENAX FORTE



Autovetture e veicoli industriali



Veicoli e attrezzature agricole



## CARATTERISTICHE GENERALI

- *Usso Professionale*
- *Tenax Forte è un detergente molto energetico a base alcalina, autolucidante, specifico per il lavaggio con idropultrice ad acqua calda o ad acqua fredda di carrozzerie d'autovetture, veicoli industriali e macchine agricole.*

## CARATTERISTICHE TECNICHE

- *Tenax Forte si usa solitamente diluito in acqua in rapporto da 1:100 a 2:100 (1-2%) se utilizzato con nebulizzatori. Quando utilizzato con idropultrice, diluire al 5:100 a 6:100 (5-6%).*
- PH 13.0
- Biodegradabilità 90%
- Confezioni:  
It 5x4 **0609 0016**  
It 10 **0609 0017**

DETERGENTI &gt; SOLO PER IL MERCATO ITALIANO &gt; ONLY FOR ITALIAN MARKET

## EDIL DET



Edilizia

Stature, fontane,  
restauroAttrezzature  
sanitariAttrezzature  
industria  
alimentare

### CARATTERISTICHE GENERALI

- *Uso Professionale*
- *Edil Det è un detergente disincrostante specifico per l'industria alimentare e l'industria edilizia.*
- *Particolarmente indicato per togliere lo smog da muretti e da statue, per togliere il calcare dalle piscine e dalle fontane, per pulire i sanitari.*
- *Non dà luogo ad esalazioni.*

### CARATTERISTICHE TECNICHE

- *Edil Det si usa solitamente diluito in acqua in rapporto da 5:100 a 10:100 (5-10%).*
- *Quando utilizzato con idropulitrice, diluire al 10:100 (10%).*
- *PH 2.5*
- *Biodegradabilità 90%*
- *Confezioni:*  
It 5x4 **0609 0018**  
It 10 **0609 0019**

## TESSIL DET

● *Per bidoni aspiratutto con lancia lavamoquette*

### CARATTERISTICHE GENERALI

- *Tessil Det è un detergente industriale costituito da una miscela di sostanze attive a bassa schiumosità.*
- *Particolarmente efficace per la pulizia di poltrone, tappeti, moquette, tappezzeria, interni auto.*
- *Lascia un delicato e gradevole odore di profumo fresco.*

### CARATTERISTICHE TECNICHE

- *Tessil Det si usa solitamente diluito in acqua in rapporto da 10:100 (10%).*
- *PH 12.7*
- *Biodegradabilità 90%*
- *Confezioni:*  
It 5x1 **0609 0026**

SPECIAL PRODUCTS FOR H.P. CLEANERS - PRODOTTI SPECIALI PER IDROPULITRICI AD ACQUA CALDA

## ACID SER disincrostante



### CARATTERISTICHE GENERALI

- *Acid Ser è un disincrostante per eliminare i depositi calcarei nelle serpentine delle idropultrici, senza danneggiare il materiale a contatto con il liquido.*

### CARATTERISTICHE TECNICHE

- *Acid Ser si usa diluito con acqua al 10%.*
- *Lasciare agire il prodotto per 12-16 ore nella*
- *PH < 1*
- *Confezioni:*  
It 10 **0060 0002**

## NO KAL anticalcare



### CARATTERISTICHE GENERALI

- *No Kal è un anticalcare liquido che previene la formazione di calcare nelle serpentine delle idropultrici.*

### CARATTERISTICHE TECNICHE

- *No Kal si usa nella tanica anticalcare delle idropultrici.*
- *PH < 7*
- *Confezioni:*  
It 5 **0060 0006**  
It 10 **0060 0005**  
It 20 **0060 0003**

## Sabbia



### CARATTERISTICHE GENERALI

- *Sabbia silicea.*

### CARATTERISTICHE TECNICHE

- *Sabbia silicea grani 0,6 - 1,2*
- *Confezioni:*  
Kg 25 **3048 0001**

## Bicarbonato di Sodio



### CARATTERISTICHE GENERALI

- *Bicarbonato di Sodio per lance sabbianti.*

### CARATTERISTICHE TECNICHE

- *Bicarbonato di Sodio per lance sabbianti.*
- *Confezioni:*  
Kg 25 **3048 0003**



















## BLUE SERIES COMMERCIAL

				X STAR		KR	KL						KSM				KS		
				CLASSIC	EXTRA	1100	CLASSIC 1300	EXTRA 1300	CLASSIC 1400	EXTRA 1400	CLASSIC 1600	EXTRA 1600	CLASSIC 1450	EXTRA 1450	CLASSIC 1480	EXTRA 1480	CLASSIC 1600	EXTRA 1600	
<b>Accessories • Accessori</b>																			
<b>Gun kit with guard • Kit pistola con protezione</b>																			
	Gun • Pistola		2410 0097	●	●		●	●	●	●	●	●	●	●	●	●			
	GC 251	G1/4M	2410 0118														●	●	
	GC 251	G3/8M	2410 0120																
	MV 2006 +pressure unloader valve MV 2006 +regolatore pressione	G1/4M	2410 0159										*	*	*	*	*	*	
		G3/8M	2410 0165																
	Gun • Pistola		2410 0170			●													
	GC 251 + Swivel		2410 0174																
<b>Lance kit without nozzle • Kit lancia senza ugello</b>																			
	Adjustable jet Getto regolabile	mm 500	3301 0935																
	Securfix		3301 1118	●	●		●	●	●	●	●	●							
<b>Lance kit with nozzle • Kit lancia con ugello</b>																			
	Diritta • Straight	ø 0,9	3301 0803										●	●	●	●			
	Angolata • Bent	ø1,1	3301 1054																
	Angolata • Bent	ø1,2	3301 0927																
	Angolata • Bent	ø1,15	3301 0933														●	●	
	Angolata • Bent	ø1,3	3301 1016																
	Angolata • Bent	ø1,25	3301 1064																
	Diritta • Straight		3301 1209			●													
<b>Lance nozzle • Ugello lancia</b>																			
		ø 1,09	3400 0400										●	●	●	●			
		ø 1,1	3400 0506																
		ø 1,14	3400 0402																
		ø 1,2	3400 0416																
		ø 1,15	3400 0508														●	●	
		ø 1,19	3400 0397																
		ø 1,25	3400 0510																
		ø 1,27	3400 0392																
		ø 1,3	3400 0512																
<b>Lance hose kit with rotating nozzle • Kit tubo lancia con ugello rotante</b>																			
	Straight • Diritta	04	3301 0777																
	Straight • Diritta	035	3301 0781																
	Straight • Diritta		3301 0804										*	●	*	●			
	Bent • Angolata	028	3301 1151														*	●	
	Bent • Angolata	033	3301 1052																
	Bent • Angolata	037	3301 1024																
	Straight • Diritta		3301 1211			●													
<b>Securfix nozzle head kit • Kit testina ugello Securfix</b>																			
		ø 1,0	3217 0250				●	●											
		ø 1,05	3217 0252	●	●				●	●									
		ø 1,15	3217 0256								●	●							
<b>Securfix rotating nozzle head kit • Kit testina ugello rotante Securfix</b>																			
		022	3217 0246	*	●		*	●	*	●									
		028	3217 0248								*	●							
<b>Foam lance kit • Kit lancia schiumogena</b>																			
			3301 0766																
			3301 0795										●	●	●	●	●	●	
			3301 1061	●	●		●	●	●	●	●	●							
			3301 1127																
			3301 1213			●													



		KT				STATIC					ETM		KA												
CLASSIC 1700	EXTRA 1700	CLASSIC 1750	EXTRA 1750	CLASSIC 1800	EXTRA 1800	CLASSIC 1900	EXTRA 1900	CLASSIC 1700	EXTRA 1700	EXTRA 1700 T.A.	CLASSIC 1900	EXTRA 1900	ETM 130	ETM 100	CLASSIC 2800	CLASSIC 3000	CLASSIC 3200	CLASSIC 5000	EXTRA 2800	EXTRA 3000	EXTRA 3200	EXTRA 4000	EXTRA 5000		
●	●	●	●	●	●	●	●	●	●	●	●	●							●	●	●	●	●	●	
*	*	*	*	*	*	*	*	*	*	*	*	*					*	*	*	*	*	*	*	*	*
													●	●											
													●	●	*	●	●	●	*	●	●	●	●		
								●	●	●															
●	●	●	●	●	●	●	●				●	●													
								●	●	●			●	●											
●	●	●	●	●	●	●	●				●	●													
								●	●	●				●											
●	●	●	●	●	●	●	●				●	●	●												
											●	●													
*	●		●		●		●																*	*	
																		*						*	
								*	●	●															
											*	●	*	*	*	*	*	*	*	*	*	*	*		
								●	●	●	●	●													

## BLUE SERIES COMMERCIAL

			X STAR		KR	KL						KSM				KS	
Accessories • Accessori			CLASSIC	EXTRA	1100	CLASSIC 1300	EXTRA 1300	CLASSIC 1400	EXTRA 1400	CLASSIC 1600	EXTRA 1600	CLASSIC 1450	EXTRA 1450	CLASSIC 1480	EXTRA 1480	CLASSIC 1600	EXTRA 1600
<b>Rotating brush • Idrospazzola rotante</b>																	
	l/min 8 ÷ 11	1413 0029															
		1413 0032	*	●		*	●	*	●	*	●	*	*	*	*	*	*
		1413 0033	*	*		*	*	*	*	*	*	*	*	*	*	*	*
		1413 0047															
<b>Drain cleaning kit • Kit sonda spurgatubi</b>																	
	m 8	3045 0028	*	*		*	*	*	*	*	*	*	*	*	*	*	*
	m 15	3045 0029									*	*	*	*	*	*	*
	m 25 6 ÷ 9 l/min	3045 0034															
	m 25 10-15 l/min	3045 0041															
<b>Floor cleaning lance kit • Kit tubo lancia pavimenti</b>																	
	SC 155	3301 0710									*	*	*	*	*	*	
	SC 140	3301 1008	*	*		*	*	*	*	*	*	*	*	*	*	*	*
	SC 140	3301 1146															
<b>Double barrel lance kit • Kit lancia canna doppia</b>																	
	mm 700	3301 0941															
	+ nozzle + ugello ø4 2540	3400 0391															
<b>Sandblasting kit • Kit lancia sabbiante</b>																	
	Ø 1,2	3301 0771															
	Ø 1,4	3301 0772															
		3301 0801							*	*	*	*	*	*	*	*	*
<b>Delivery hose kit • Kit tubo mandata</b>																	
	m 15 R1-1/4"	3208 0971															
	m 8 R1-1/4"	3208 1012															
	m 8 R1-5/16"	3301 1221															
	m 8 R1-1/4"	3208 1013															
	m 10 R1-1/4"	3301 0689															
	m 8 R1-1/4"	3301 0769															
	m 8 R1-1/4"	3301 0767					●		●		●					●	
	m 10 R1-1/4"	3301 0794															●
	m 10 R1-1/4"	3301 0806															
	m 6 R1-1/4"	3301 1035	●	●		●		●		●							
	m 7 R1-1/4"	3301 1048										●		●			
	m 20 R1-1/4"	3301 1102															
	m 12 R1-5/16"	3301 1134															
	m 20 R1-1/4"	3301 1185															
	m 5 R1-1/4"	3301 1207								●							
<b>Delivery hose kit • Kit tubo mandata speciale</b>																	
	m 8 R1-1/4"	3301 0612															
	m 8 R1-1/4"	3301 0785														*	
	m 8 R1-5/16"	3301 1218															
<b>Delivery hose extension kit • Kit prolunga tubo mandata</b>																	
	m 8	3301 0788	*	*		*	*	*	*	*	*	*	*	*	*	*	*
	m 8 R1-1/4"	3301 0811										*		*		*	*
	m 4	3301 1028	*	*		*	*	*	*	*	*	*	*	*	*	*	*
	m 10 R1-1/4"	3301 1124															

		KT						STATIC					ETM		KA									
CLASSIC 1700	EXTRA 1700	CLASSIC 1750	EXTRA 1750	CLASSIC 1800	EXTRA 1800	CLASSIC 1900	EXTRA 1900	CLASSIC 1700	EXTRA 1700	EXTRA 1700 T.A.	CLASSIC 1900	EXTRA 1900	ETM 130	ETM 100	CLASSIC 2800	CLASSIC 3000	CLASSIC 3200	CLASSIC 5000	EXTRA 2800	EXTRA 3000	EXTRA 3200	EXTRA 4000	EXTRA 5000	
													*	*	*	*	*	*	*	*	*	*	*	*
*	*	*	●	*	●	*	●	*	*	*	*	*												
*	*	*	*	*	*	*	*	*	*	*	*	*												
								*	●	●	*	●												
*	*	*	*	*	*	*	*	*	*	*	*	*												
*	*	*	*	*	*	*	*	*	*	*	*	*			*									
													*	*					*					
															*		*	*	*	*	*	*	*	*
*	*	*	*	*	*	*	*	*	*	*	*	*			*	*	*	*	*	*	*	*	*	*
		*	*					*	*	*		*												
*	*			*	*	*	*				*	*												
													*	*	*	*	*	*	*	*	*	*	*	*
													*	*	*	*	*	*	*	*	*	*	*	*
*	*	*	*	*	*	*	*	*	*	*	*	*			*	*	*	*	*	*	*	*	*	*
																		*	*	*	*	*	*	*
●	●							●			●		●	●					●	●	●	●	●	●
															*	*	*	*						
*		●		●																				
						●																		
*	*	*	*	*	*	*	*																	
	*		*		*		*																	
								*	*	*	*	*												

## BLUE SERIES COMMERCIAL

				X STAR		KR	KL						KSM				KS	
Accessories • Accessori				CLASSIC	EXTRA	1100	CLASSIC 1300	EXTRA 1300	CLASSIC 1400	EXTRA 1400	CLASSIC 1600	EXTRA 1600	CLASSIC 1450	EXTRA 1450	CLASSIC 1480	EXTRA 1480	CLASSIC 1600	EXTRA 1600
<b>Hose reel kit • Kit avvolgitubo girevole</b>																		
	m 10	R1-1/4"	7002 0265															*
	m 10	R1-1/4"	7002 0273									*		*				
	m 12	R1-1/4"	7002 0292															
<b>Spiral suction hose kit • Kit tubo aspirazione spiralato</b>																		
	m 8		3299 0019															
<b>Suction hose kit with quick coupling • Kit attacco rapido aspirazione acqua</b>																		
			5002 0021	*	*		*	*	*	*	*	*	*	*	*	*	*	*
<b>Suction hose with quick coupling • Attacco rapido aspirazione acqua</b>																		
			2803 3387															
<b>Suction hose kit with quick coupling kit • Kit tubo aspirazione con kit attacco rapido</b>																		
			3208 0783	*	*							*	*	*	*	*	*	*
<b>Regulated detergent suction cap kit • Kit tappo aspirazione regolazione detergente</b>																		
			3312 0014															
<b>Back-flow preventer kit BA 10 • Kit disconnettore idrico BA 10</b>																		
	G3/4M G3/4M		0608 0049	*	*	*	*	*	*	*	*	*	*	*	*	*	*	*
	Garden hose quick couplers Kit raccordi attacco rapido	G3/4F G3/4F	5002 0024	*	*	*	*	*	*	*	*	*	*	*	*	*	*	*
<b>Suction coupling kit • Kit raccordo aspirazione</b>																		
			2803 3429			●												
<b>Water filter • Filtro acqua</b>																		
			1002 0231			●												
<b>Accessory rack • Supporto accessori</b>																		
			3002 0688															
<b>Hose cleaning guide kit • Kit guida tubo</b>																		
			5018 0084															

		KT						STATIC					ETM		KA									
CLASSIC 1700	EXTRA 1700	CLASSIC 1750	EXTRA 1750	CLASSIC 1800	EXTRA 1800	CLASSIC 1900	EXTRA 1900	CLASSIC 1700	EXTRA 1700	EXTRA 1700 T.A.	CLASSIC 1900	EXTRA 1900	ETM 130	ETM 100	CLASSIC 2800	CLASSIC 3000	CLASSIC 3200	CLASSIC 5000	EXTRA 2800	EXTRA 3000	EXTRA 3200	EXTRA 4000	EXTRA 5000	
*																								
		*		*		*																		
													*	*	*	*	*	*	*	*	*	*	*	*
*	*	*	*	*	*	*	*	*	*	*	*	*												
													*	*	*	*	*	*	*	*	*	*	*	*
*	*	*	*	*	*	*	*																	
		*	*	*	*	*	*																	
*	*	*	*	*	*	*	*	*	*	*	*	*	*	*	*	*	*	*	*	*	*	*	*	*
*	*	*	*	*	*	*	*	*	*	*	*	*	*	*	*	*	*	*	*	*	*	*	*	*
								●	●	●	●	●												
								*	*	*	*	*												

● Standard accessories • Dotazione standard \* Accessories • Accessori

## BLUE SERIES PROFESSIONAL

			K 250										K COMPACT			K PREMIUM									
			EXTRA 10/150	CLASSIC 10/150	EXTRA 12/130	CLASSIC 12/130	EXTRA 11/160	CLASSIC 11/160	EXTRA 13/190	CLASSIC 13/190	EXTRA 15/170	CLASSIC 15/170	EXTRA 11/210	CLASSIC 11/210	11/120	13/180	15/160	13/190	15/170	15/210	21/160	15/230	21/180		
<b>Accessories • Accessori</b>																									
<b>Gun kit with guard • Kit pistola con protezione</b>																									
	GH 351 + swivel		2410 0114																						
	GC 251		2410 0120	●		●		●		●		●													
	GC 251 + prolunga + swivel		2410 0174																						
	GH 301 + Swivel		2410 0182	●	*	●	*	●	*	●	*	●	*												
	GH 351 + revolving lance GH 351 + lancia girevole		2410 0124											*	*	*	*	*	*	*	*	*	*	*	*
	GH 351 + fixed lance GH 351 + lancia fissa		2410 0126											*	*	*	*	*	*	*	*	*	*	*	*
	Spray gun lance kit LC 04 Kit pistola lancia LC04		3301 1191																						
	Spray gun (included in kit 3301/1191) Pistola (inclusa nel kit 3301/1191)		2410 0167																						
	GH351 INOX + Swivel		2410 0184																						
	RL51 + Swivel + ball quick coupler RL51 + Swivel + attacco rapido a sfere		2410 0194																						
	GH 501 con attacchi rapidi GH 501 with quick couplers		2410 0195																						
<b>Bent lance hose kit, detergent head, without nozzle • Kit tubo lancia angolata testina detergente senza ugello</b>																									
	mm 500	3301 0935	●	●	●	●	●	●	●	●	●	●	●												
	mm 700	3301 0976												●	●	●	●	●	●	●	●	●	●	●	●
	mm 900 INOX	3301 1225																							
	mm 500 INOX	3301 1244																							
	mm 1200 INOX	3301 1245																							
<b>Double barrel lance kit • Kit tubo lancia canna doppia</b>																									
	mm 700	3301 0941	*	*	*	*	*	*	*	*	*	*	*	*	*	*	*	*	*	*	*	*	*	*	*
	mm 700 INOX	3301 1222																							
	mm 800	3301 1323																							
	+det. nozzle + ugello det.	ø 4	3400 0391	*	*	*	*	*	*	*	*	*	*	*	*	*	*	*	*	*	*	*	*	*	*
<b>Stainless-steel lance with rotating nozzle with quick coupler M24x1,5 (600 bar) • Lancia inox con ugello rotante con attacchi rapidi M24x1,5</b>																									
	030 inox	3301 1324																							
	035 inox	3301 1332																							
	040 inox	3301 1325																							
	045 inox	3301 1326																							
	050 inox	3301 1327																							
	075 ottone	3301 1328																							
	090 ottone	3301 1329																							
	15 ottone	3301 1331																							
<b>Lance hose kit with rotating nozzle • Kit tubo lancia con ugello rotante</b>																									
	04	3301 0777	●	*			●	*										*							
	035	3301 0781											●	*											
	045	3301 0782														*	*				*		*		
	05	3301 0893			●	*																			
	055	3301 0895										●	*				*		*						
	07	3301 0899																							*
	08	3301 1003																				*			
<b>Stainless steel straight rotating nozzle lance with ball quick coupler • Lancia dritta inox ugello rotante con attacco rapido a sfere</b>																									
	045	3301 1305																							
	050	3301 1306																							
	060	3301 1307																							
	070	3301 1308																							
	080	3301 1309																							
	10	3301 1310																							
	13	3301 1311																							
	20	3301 1312																							















## BLUE SERIES PROFESSIONAL

			K 250											K COMPACT			K PREMIUM								
			EXTRA 10/150	CLASSIC 10/150	EXTRA 12/130	CLASSIC 12/130	EXTRA 11/160	CLASSIC 11/160	EXTRA 13/190	CLASSIC 13/190	EXTRA 15/170	CLASSIC 15/170	EXTRA 11/210	CLASSIC 11/210	11/120	13/180	15/160	13/190	15/170	15/210	21/160	15/230	21/180		
<b>Accessories • Accessori</b>																									
<b>Lance hose jet kit • Kit tubo lancia getto</b>																									
	ø 1,40	3301 0909																*							
	ø 1,50	3301 0911													*	*				*			*		
	ø 1,62	3301 0915															*		*						
	ø 1,80	3301 1085																						*	
	ø 2,0	3301 1087																				*			
<b>Stainless steel rotating nozzle head • Testina ugello rotante inox 0°</b>																									
	030	3217 0279																							
	040	3217 0280																							
	050	3217 0281																							
	035	3217 0283																							
	075	3217 0284																							
	090	3217 0287																							
	15	3217 0286																							
045	3217 0294																								
<b>Sandblasting lance kit • Kit lancia sabbiante</b>																									
	ø 1,2	3301 0771	*	*								*	*												
	ø 1,4	3301 0772			*	*	*	*	*	*	*	*			*	*	*	*	*	*		*			
	085	3301 0863																							
	ø 1,8	3301 0972																				*		*	
<b>Sandblasting lance kit, with ball quick coupler • Kit lancia sabbiante, con attacco rapido a sfere</b>																									
	075	3301 1316																							
	085	3301 1317																							
<b>Sandblasting lance kit, with ball quick coupler + rubber suction hose + 15° nozzle • Kit lancia sabbiante, con attacco rapido a sfere + tubo</b>																									
	055 500 bar	3301 1318																							
	050 500 bar	3301 1320																							
	080 500 bar	3301 1321																							
	09 500 bar	3301 1322																							
	040 500 bar	3301 1333																							
	050 500 bar	3301 1334																							
	080 500 bar	3301 1335																							
	09 500 bar	3301 1336																							
<b>Professional sandblasting lance kit • Kit lancia sabbiante professionale</b>																									
	055	3301 0864																*	*	*		*			
	09	3301 0865																				*		*	
<b>Fan shape nozzle 15° or 25°, 1/4" MEG connection (max 350 bar) • Ugello con getto a lama 15° o 25°, attacco 1/4" Meg (max 350 bar)</b>																									
	15 035	3400 0402												●	●										
	15 040	3400 0397	●	●				●	●																
	15 045	3400 0392											●	●											
	15 050	3400 0389			●	●																			
	15 055	3400 0408										●	●												
	25 040	3400 0419													●					●			●		
	25 040	3400 0420																							
	25 040	3400 0386														●									
	25 045	3400 0602																							
	25 050	3400 0375																							
	25 055	3400 0376																●							
	25 055	3400 0423																		●					
	25 060	3400 0421																							
	25 070	3400 0519																							
	25 070	3400 0601																							
	25 075	3400 0425																						●	
	25 075	3400 0600																							
	25 080	3400 0491																					●		
	25 085	3400 0406																							
	25 10	3400 0488																							
	25 13	3400 0489																							
	25 20	3400 0647																							



K STEEL S				K STEEL TS						K STEEL ECO			K STEEL					K Xtreme						K STEEL													
803	805	807	809	803	805	807	809	801	901	809 21/150T	801 15/210	901 21/180	1001		1251		1501	15/500	21/350	33/250	18/500	21/450	42/200	2000			2500										
													21/210	28160	21/250	33/160	42/130								15/500	18/400	21/350	30/300	21/450								
																		*								*											
																			*								*										
																			*								*										
																				*							*										
																				*							*										
																				*							*										
																				*							*										
																				*							*										
																				*							*										
																				*							*										
																				*							*										
																				*							*										
																				*							*										
																				*							*										
																				*							*										
																				*							*										
																				*							*										
																				*							*										
																				*							*										
																				*							*										
																				*							*										
																				*							*										
																				*							*										
																				*							*										
																				*							*										
																				*							*										
																				*							*										
																				*							*										
																				*							*										
																				*							*										
																				*							*										
																				*							*										
																				*							*										
																				*							*										
																				*							*										
																				*							*										
																				*							*										
																				*							*										
																				*							*										
																				*							*										
																				*							*										
																				*							*										
																				*							*										
																				*							*										
																				*							*										
																				*							*										
																				*							*										
																				*							*										
																				*							*										
																				*							*										
																				*							*										
																				*							*										
																				*							*										
																				*							*										
																				*							*										
																				*							*										
																				*							*										
																				*							*										
																				*							*										
																				*							*										
																				*							*										
																				*							*										
																				*							*										
																				*							*										
																				*							*										
																				*							*										
																				*							*										
																				*							*										
																				*							*										
																				*							*										
																				*							*										
																				*							*										
																				*							*										
																				*							*										

**BLUE SERIES PROFESSIONAL**

Accessories • Accessori		K 250											K COMPACT			K PREMIUM							
		EXTRA 10/150	CLASSIC 10/150	EXTRA 12/130	CLASSIC 12/130	EXTRA 11/160	CLASSIC 11/160	EXTRA 13/190	CLASSIC 13/190	EXTRA 15/170	CLASSIC 15/170	EXTRA 11/210	CLASSIC 11/210	11/120	13/180	15/160	13/190	15/170	15/210	21/160	15/230	21/180	
<b>Washing lance with ball quick coupler, without nozzle</b> • <i>Lancia lavaggio con attacco rapido a sfere, senza ugello</i>																							
	1603 0133																						
<b>Washing lance with ball quick coupler, without nozzle</b> • <i>Lancia lavaggio con attacco rapido a sfere, senza ugello</i>																							
	1603 0134																						
<b>Fan shape nozzle 0°, 1/4" MEG connection (max 350 bar)</b> • <i>Ugello con getto a lama 0°, attacco 1/4" Meg (max 350 bar)</i>																							
	0 030	3400 0619																					
	0 035	3400 0621																					
	0 040	3400 0620																					
	0 045	3400 0605																					
	0 050	3400 0622																					
	0 070	3400 0604																					
	0 075	3400 0603																					
	0 075	3400 0623																					
	0 090	3400 0645																					
	0 15	3400 0626																					
<b>Flat stainless-steel jet nozzle (15° or 25°) with ceramic insert</b> • <i>Ugello inox getto piatto 15° o 25° con inserto in ceramica</i>																							
	15 030	3400 0614																					
	15 035	3400 0615																					
	15 040	3400 0616																					
	15 045	3400 0659																					
	25 050	3400 0618																					
	25 075	3400 0617																					
	25 090	3400 0644																					
	25 15	3400 0611																					
<b>Nozzle for sandblasting head</b> • <i>Ugello per testa sabbiante</i>																							
	15° - 040	3400 0578																					
	15° - 050	3400 0594																					
	15° - 080	3400 0595																					
	15° - 090	3400 0483																					
<b>Fan-shape nozzle for washing lance and foam lance (M15x1)</b> • <i>Ugello ventaglio per lancia lavaggio e schiumogena (M15x1)</i>																							
	1,5 mm	3400 0662																					
	2,0 mm	3400 0663																					
	2,3 mm	3400 0664																					
	3,0 mm	3400 0665																					
<b>Rotating Brush</b> • <i>Idrospazzola rotante</i>																							
	8÷11 l/min	1413 0029	*	*	*	*	*	*	*	*	*	*	*	*	*	*	*	*	*	*	*	*	
	13÷18 l/min	1413 0030																*	*	*	*	*	
<b>Foam lance kit with regulator</b> • <i>Kit lancia schiumogena con regolatore</i>																							
		3301 0901																*	*	*	*	*	*
		3301 0766	*	*	*	*	*	*	*	*	*	*	*	*	*	*	*	*	*	*	*	*	*
<b>Foam lance with ball quick coupler</b> • <i>Lancia schiumogena con attacco rapido a sfere</i>																							
	3301 1303																						
<b>Floor cleaning lance kit</b> • <i>Kit tubo lancia lavapavimenti</i>																							
	SC 155	3301 0710	*	*	*	*	*	*	*	*	*	*	*	*	*	*	*	*	*	*	*	*	
<b>Stainless steel floor cleaning lance kit (gun not supplied)</b> • <i>Lancia lavapavimenti inox (pistola non fornita)</i>																							
		3301 1253																					
<b>Professional stainless steel floor cleaning lance</b> • <i>Lancia lavapavimenti professionale inox</i>																							
		3301 1252																					
<b>Drain cleaning kit, 25 m</b> • <i>Kit sonda spurgatubi m 25</i>																							
	16÷21 l/min	3045 0036																			*	*	
	10÷15 l/min	3045 0041	*	*	*	*	*	*	*	*	*	*	*	*	*	*	*	*	*	*	*	*	

K STEEL S				K STEEL TS					K STEEL ECO			K STEEL					K Xtreme						K STEEL							
803	805	807	809	803	805	807	809	801	901	809 21/150T	801 15/210	901 21/180	1001		1251		1501	15/500	21/350	33/250	18/500	21/450	42/200	2000			2500			
													21/210	28160	21/250	33/160	42/130								15/500	18/400	21/350	30/300	21/450	
													*	*	*	*	*													
													*	*	*	*	*													
																		*				*								
											*											*							*	
										*		*							*				*						*	
																		*							*				*	
																		*				*				*			*	
														*		*									*		*		*	
														*		*										*		*		*
																*														
																			*			*								
*																														
	*	*	*																											
*	*	*	*	*	*	*	*	*	*																					
										*	*	*	*	*	*	*														
										*	*	*																		
										*	*	*																		
*	*	*	*	*	*	*	*	*	*																					

## BLUE SERIES PROFESSIONAL

			K 250											K COMPACT			K PREMIUM								
			EXTRA 10/150	CLASSIC 10/150	EXTRA 12/130	CLASSIC 12/130	EXTRA 11/160	CLASSIC 11/160	EXTRA 13/190	CLASSIC 13/190	EXTRA 15/170	CLASSIC 15/170	EXTRA 11/210	CLASSIC 11/210	11/120	13/180	15/160	13/190	15/170	15/210	21/160	15/230	21/180		
<b>Accessories • Accessori</b>																									
<b>Drain cleaning kit, 25 m with ball quick coupler • Kit sonda spurgatubi m 25 con attacco rapido a sfere</b>																									
	16+21 l/min	3045 0047																							
	22+33 l/min	3045 0048																							
	10+15 l/min	3045 0050																							
	16+29 l/min	3045 0051																							
	30+42 l/min	3045 0052																							
<b>Rubber delivery hose kit • Kit tubo gomma mandata</b>																									
	m 15 R1-1/4"	3208 0971	●		●		●		●		●		●												
	m 8 R1-1/4"	3208 1012													●	●	●								
	m 10 R1-1/4"	3208 1050		●		●		●		●		●		●											
	m 10 R2-5/16"	3301 0776																					●		
	m 10 R2-3/8"	3301 0944																							
	m 10 R1-5/16"	3301 0987																							
	m 20 R2-3/8" 600 bar	3301 1226																	●	●	●	●		●	
	m 20 R2-1/2" 310 bar	3301 1268																							
	m 20 R2-1/2" 310 bar	3301 1269																							
	m 20 R2-3/8" 400 bar	3301 1270																							
	m 20 R2-3/8" 400 bar	3301 1271																							
	m 10 R2-1/2"	3301 1286																							
	m 10 R2-3/8"	3301 1314																							
<b>Food-industry rubber delivery hose kit • Kit tubo gomma mandata anti-traccia</b>																									
	m 10 R1-5/16"	3301 0559																							
	m 10 R2-5/16"	3301 0599																							
	m 10 R2-3/8"	3301 1247																							
<b>Rubber delivery hose extension kit SAE 100 • Kit prolunga tubo gomma mandata SAE 100</b>																									
	m 8 R1-1/4"	3301 0769	*	*	*	*	*	*	*	*	*	*	*	*	*	*	*	*	*	*	*	*	*	*	
	m 10 R1-5/16"	3301 0774														*	*	*	*	*	*	*	*	*	
	m 10 R2-3/8"	3301 0946																							
	m 10 R2-5/16"	3301 0985																					*		
	m 20 R2-3/8"	3301 1255																							
m 30 R2-1/2"	3301 1278																								
<b>Food-industry rubber delivery hose extension kit • Kit prolunga tubo gomma mandata anti-traccia</b>																									
	m 10 R2-5/16"	3301 1249																							
	m 10 R1-5/16"	3301 1248																							
	m 10 R2-3/8"	3301 1250																							
<b>Hose reel with rubber hose • Avvolgitubo girevole con tubo gomma</b>																									
	m 15 R1-1/4"	7002 0241													●	●	●								
	m 15 R1-5/16"	7002 0279																	●	●	●	●		●	
	m 15 R1-1/4"	7002 0280													*	*	*								
	m 15 R1-5/16"	7002 0281																	*	*	*	*		*	
	m 15 R2-5/16"	7002 0285																					●		
	m 15 R2-3/8"	7002 0287																					*		
	m 15 R1-5/16"	7002 0315																							
	m 15 R2-5/16"	7002 0316																							
	m 15 R2-3/8"	7002 0317																							
	stainless steel with blue food-industry hose, 20 m - inox con tubo blu antitr.	m 20 R2-5/16"	7002 0304																						
stainless steel without rubber hose inox senza tubo gomma	max 30 m R2-5/16"	7002 0329																							
	max 40 m R1-5/16"																								
	m 15 R1-1/4"	7002 0330		*		*		*		*		*		*		*									
	m 20 R1-1/16"	7002 0332		*		*		*		*		*		*		*									
<b>Hose reel kit • Kit avvolgitubo</b>																									
	m 20 R2-1/2" 310 bar	7002 0359																							
	m 20 R2-3/8" 600 bar	7002 0360																							
	m 20 R2-3/8" 600 bar	7002 0354																							

K STEEL S				K STEEL TS					K STEEL ECO			K STEEL					K Xtreme						K STEEL										
803	805	807	809	803	805	807	809	801	901	809 21/150T	801 15/210	901 21/180	1001		1251		1501	15/500	21/350	33/250	18/500	21/450	42/200	2000			2500						
														21/210	28160	21/250	33/160	42/130							15/500	18/400	21/350	30/300	21/450				
										*	*	*		*		*		*															
															*		*				*				*			*		*		*	*
																				*		*											
																					*		*										
																					*		*										
																					*		*										
																					*		*										
																					*		*										
																					*		*										
																					*		*										
																					*		*										
																					*		*										
																					*		*										
																					*		*										
																					*		*										
																					*		*										
																					*		*										
																					*		*										
																					*		*										
																					*		*										
																					*		*										
																					*		*										
																					*		*										
																					*		*										
																					*		*										
																					*		*										
																					*		*										
																					*		*										
																					*		*										
																					*		*										
																					*		*										
																					*		*										
																					*		*										
																					*		*										
																					*		*										
																					*		*										
																					*		*										
																					*		*										
																					*		*										
																					*		*										
																					*		*										
																					*		*										
																					*		*										
																					*		*										
																					*		*										
																					*		*										
																					*		*										
																					*		*										
																					*		*										
																					*		*										
																					*		*										
																					*		*										
																					*		*										
																					*		*										
																					*		*										
																					*		*										
																					*		*										
																					*		*										
																					*		*										
																					*		*										
																					*		*										
																					*		*										
																					*		*										
																					*		*										
																					*		*										
																					*		*										
																					*		*										
																					*		*										
																					*		*										
																					*		*										
																					*		*										
																					*		*										
																					*		*										
																					*		*										
																					*		*										
																					*		*										
																					*		*										
																					*		*										
																					*		*										
																					*		*										

**BLUE SERIES PROFESSIONAL**

			<b>K 250</b>											<b>K COMPACT</b>			<b>K PREMIUM</b>							
			EXTRA 10/150	CLASSIC 10/150	EXTRA 12/130	CLASSIC 12/130	EXTRA 11/160	CLASSIC 11/160	EXTRA 13/190	CLASSIC 13/190	EXTRA 15/170	CLASSIC 15/170	EXTRA 11/210	CLASSIC 11/210	11/120	13/180	15/160	13/190	15/170	15/210	21/160	15/230	21/180	
<b>Accessories • Accessori</b>																								
<b>Stainless steel hose reel kit with rubber hose • Kit avvolgitubo inox con tubo gomma blu</b>																								
	m 20 R2-3/8" 600 bar	7002 0339																						
	max m 20 R2-5/16" without rubber hose senza tubo gomma	7002 0343																						
	max m 30 R1-5/16" without rubber hose senza tubo gomma																							
<b>Inox hose reel kit complete with Blue hose • Kit avvolgitubo inox con tubo Blu anti-macchia</b>																								
	m 20 R2-1/2"	7002 0345																						
	m 20 R2-3/8"	7002 0346																						
	m 40 R2-1/2"	7002 0366																						
	m 60 R1-1/2"	7002 0367																						
<b>Static kit complete with on-wall mounting frame • Kit Static completo di telaio e fissaggio a muro</b>																								
	m 20 R1-1/4"	5018 0076													*		*							
	m 20 R1-5/16"	5018 0077																*	*	*		*	*	
	m 20 R2-5/16"	5018 0105																*	*	*		*	*	
<b>Mobile kit complete with internal metal frame, handle and wheel kit • Kit Mobile completo di telaio supporto, manico e kit ruote</b>																								
		5018 0078													*		*							
		5018 0079																*	*	*		*	*	
<b>Spiral suction hose kit • Kit tubo aspirazione spiralato</b>																								
	m 8	3299 0019	*	*	*	*	*	*	*	*	*	*	*	*	*	*	*	*	*	*	*	*	*	*
<b>Suction hose with quick coupling • Attacco rapido aspirazione acqua</b>																								
		2803 3387	*	*	*	*	*	*	*	*	*	*	*	*										
<b>Detergent tank bracket • Supporto tanica detergente</b>																								
	lt 5	3002 0751																						
<b>Injector kit • Kit eiettore</b>																								
	ø 2,7	3410 0333																						
	ø 2,7	3410 0372																						
<b>Back-flow preventer kit BA 10 • Kit disconnettore idrico BA 10</b>																								
	G3/4M G3/4M	0608 0049	*	*	*	*	*	*	*	*	*	*	*	*	*	*	*	*	*	*	*	*	*	*
 Garden hose quick coupler kit 3/4 Kit raccordi attacco rapido 3/4	G3/4F G3/4F	5002 0024	*	*	*	*	*	*	*	*	*	*	*	*	*	*	*	*	*	*	*	*	*	*
<b>Water suction filter in brass • Filtro aspirazione acqua</b>																								
	G3/4F G3/4F	1002 0159																						
<b>Water filter • Filtro acqua</b>																								
	100 Mesh 110 l/min	1002 0233																						
	80 Mesh	1002 0241																						
<b>100 mesh cartridge for water filter • Cartuccia 100 mesh per filtro acqua</b>																								
	100 Mesh	1002 0235																						
	80 Mesh	1002 0242																						
<b>Foot pedal valve • Valvola pedale</b>																								
	G 3/8 M	0608 0071																						
<b>Quickfit kit • Kit attacco rapido</b>																								
	M22	0011 0026																						
<b>Stainless steel lance hose kit with foam nozzle + quick kit M22 • Kit tubo lancia inox con ugello schiuma + kit attacco rapido M22</b>																								
	mm 500 M22	3301 1275																						
<b>Stainless steel foam system device • Dispositivo sistema schiuma inox</b>																								
		0608 0076																						
<b>Protective clothing kit • Kit abbigliamento protettivo</b>																								
		0608 0070																						

K STEEL S				K STEEL TS						K STEEL ECO			K STEEL						K Xtreme						K STEEL				
803	805	807	809	803	805	807	809	801	901	809 21/150T	801 15/210	901 21/180	1001		1251		1501	15/500	21/350	33/250	18/500	21/450	42/200	2000			2500		
													21/210	28/160	21/250	33/160	42/130							15/500	18/400	21/350	30/300	21/450	
										*	*	*																	
										*	*	*																	
														*	*														
														*	*	*	*	*											
														*	*	*	*	*											
*	*	*	*																										
*	*	*	*																										
*	*	*	*	*	*	*	*	*	*	*	*	*																	
										*	*	*		*	*	*													
*	*	*	*	*	*	*	*	*	*	*	*	*																	
*	*	*	*	*	*	*	*	*	*	*	*	*																	
				●	●	●	●	●	●	●	●	●																	
														●	●	●	●	●						●	●	●	●	●	
														●	●	●	●	●						●	●	●	●	●	
																		*	*	*	*	*	*	*	*	*	*	*	
										*	*	*																	
										*	*	*																	
										*	*	*																	
																		*	*	*	*	*	*	*	*	*	*	*	

**FDX 2**
**Accessories • Accessori**

			Axial Pumps Pompe Assiali						Triplex						Axial Pumps Pompe Assiali		
			10/150	12/200	11/150	13/150	12/170	14/200	12/140	13/180	14/190	16/210	16/250	15/270	11/150	13/150	12/170
<b>Gun kit • Kit pistola</b>																	
	Gun with guard <i>Pistola con protezione</i>	2410 0097	●														
	GH 351 + fixed lance (n. 2 o-ring)	2410 0114															
	GC 251	2410 0120		●													
	GH 351 + revolving lance <i>GH 351 + lancia girevole</i>	2410 0124															
	GH 351 + fixed lance <i>GH 351 + lancia fissa</i>	2410 0126															
	MV2006 + pressure unloader valve <i>MV2006 + regolatore pressione</i>	2410 0165			*	*	*	*	*	*	*	*		*	*	*	
	GH 301 + Swivel	2410 0182		●	●	●	●	●	●	●	●	●	●	●	●	●	
	GH 501	2410 0195															
<b>Lance hose kit • Kit tubo lancia</b>																	
	Straight with nozzle <i>Dritta con ugello</i>	3301 1009	●														
	Bent + det. head without nozzle <i>Angolata + testina det. senza ugello</i>	3301 0935		●													
	Bent + det. head without nozzle <i>Angolata + testina det. senza ugello</i>	3301 0787			●	●	●	●	●	●	●	●	●	●	●	●	
	Bent + det. head without nozzle <i>Angolata + testina det. senza ugello</i>	3301 0976															
	Double barrel lance kit <i>A canna doppia senza ugello</i>	3301 0941			*	*	*	*	*	*	*	*	*	*	*	*	
	mm 800	3301 1323															
<b>Nozzle • Ugello</b>																	
	Per lancia • for lance	ø 1,15 3400 0417	●														
	Detergente • detergent	ø4 2540 3400 0391			*	*	*	*	*	*	*	*	*	*	*	*	
<b>Lance with adjustable jet kit • Kit tubo lancia getto regolabile</b>																	
		ø 1,2 03 3301 0905															
		ø 1,3 035 3301 0907															
		ø 1,4 04 3301 0909			*		*						*	*		*	
		ø 1,5 045 3301 0911					*	*				*					
		ø 1,55 05 3301 0913			*			*	*	*				*			
		ø 1,62 055 3301 0915							*	*	*						
		ø 1,65 06 3301 1094															
		ø 1,8 06 3301 1085															
		ø 2,0 08 3301 1087															
<b>Lance hose kit with rotating nozzle • Kit tubo lancia ugello rotante</b>																	
		033 3301 1052	*	*													
		035 3301 1239															
		04 3301 0777				*							*	*		*	
		04 3301 1113															
		03 3301 0780															
		035 3301 0781		*													
		045 3301 0782				*		*			*						
		05 3301 0893			*			*	*	*				*			
		055 3301 0895															
		06 3301 0897															
		070 3301 0899															
		1,00 3301 0995															
		080 3301 1003															





<b>FDX Elite</b>							<b>FDX Pro</b>					<b>FDX 4</b>					<b>FDX XTREME</b>					<b>FDX HOT CUBE</b>				<b>FDX WB</b>			<b>PTO</b>					
Triplex							15/270	15/300	16/200	16/250	18/220	15/150	16/200 FW2 Yanmar	21/160 FW2 Yanmar	16/200 FW2 Honda	16/250 RW Honda	18/220 RW Honda	21/200 RW Honda	15/500	18/400	21/350	30/280	36/230	42/200	16/200 D	16/200 B	21/160 D	21/160 B	8/160 LWD-K	8/160 BWD-K	15/150	21/200	23/200	30/170
14/200	12/140	13/180	14/190	16/210	16/250	15/270																												
							●	●	●	●	●	●	●	●	●	●	●	●	●	●														
							*	*	*	*	*	*	*	*	*	*	*	*	*	*	*	*	*	*	*	*	*	*	*	*	*	*	*	
*	*	*	*	*																							*	*						
●	●	●	●	●	●	●																												
							*	*	*	*	*	*	*	*	*	*	*	*	*	*	*	*	*	*	*	*	*	*	*	*	*	*	*	
							●	●	●	●	●	●	●	●	●	●	●	●	●	●	●	●	●	●	●	●	●	●	●	●	●	●	●	

**FDX 2**
**Accessories • Accessori**

Axial Pumps Pompe Assiali						Triplex					Axial Pumps Pompe Assiali			
10/150	12/200	11/150	13/150	12/170	14/200	12/140	13/180	14/190	16/210	16/250	15/270	11/150	13/150	12/170

**Stainless-steel lance with rotating nozzle with quick coupler M24x1,5 (600 bar) • Lancia inox con ugello rotante con attacchi rapidi M24x1,5**

030 inox	3301 1324													
040 inox	3301 1325													
050 inox	3301 1327													
075 ottone	3301 1328													
12 ottone	3301 1330													
15 ottone	3301 1331													

**Fan shape nozzle 15° or 25°, 1/4" MEG connection • Ugello con getto a lama 15° or 25° attacco 1/4" MEG**

15 040	3400 0402	●												
25 030	3400 0606													
25 035	3400 0596													
25 040	3400 0388		●		●							●		●
25 040	3400 0420													
25 045	3400 0386						●			●				
25 045	3400 0419					●					●			
25 050	3400 0375			●									●	
25 050	3400 0422						●		●	●				
25 055	3400 0423													
25 060	3400 0421													
25 065	3400 0424													
25 070	3400 0541													
25 075	3400 0425													
25 080	3400 0491													
25 085	3400 0406													
25 10	3400 0523													

**Concentrated stainless-steel jet nozzle 0° with ceramic insert • Ugello inox getto concentrato 0° con inserto in ceramica**

0 030	3400 0619													
0 040	3400 0620													
0 050	3400 0622													
0 080	3400 0625													
0 11	3400 0624													
0 15	3400 0626													

0°

**Flat stainless-steel jet nozzle (15° or 25°) with ceramic insert • Ugello inox getto piatto 15° o 25° con inserto in ceramica**

15 030	3400 0614													
15 040	3400 0616													
25 050	3400 0618													
25 080	3400 0612													
25 11	3400 0613													
25 15	3400 0611													

15°-25°

**Nozzle sandblasting head and tungsten carbide • Ugello per testa sabbiante in carburo di tungsteno**

15° - 040	3400 0578													
15° - 050	3400 0594													
15° - 080	3400 0595													
15° - 090	3400 0483													



FDX Elite							FDX Pro					FDX 4					FDX XTREME					FDX HOT CUBE				FDX WB			PTO					
Triplex							15/270	15/300	16/200	16/250	18/220	15/150	16/200 FW2 Yanmar	21/160 FW2 Yanmar	16/200 FW2 Honda	16/250 RW Honda	18/220 RW Honda	21/200 RW Honda	15/500	18/400	21/350	30/280	36/230	42/200	16/200 D	16/200 B	21/160 D	21/160 B	8/160 LWD-K	8/160 BWD-K	15/150	21/200	23/200	30/170
5 (600 bar)																			*															
																				*														
																				*														

**FDX 2**
**Accessories • Accessori**

		Axial Pumps Pompe Assiali						Triplex						Axial Pumps Pompe Assiali		
		10/150	12/200	11/150	13/150	12/170	14/200	12/140	13/180	14/190	16/210	16/250	15/270	11/150	13/150	12/170
<b>Stainless steel rotating nozzle head • Testina ugello rotante 0°</b>																
	030 inox	3217 0279														
	040 inox	3217 0280														
	050 inox	3217 0281														
	075 ottone	3217 0284														
	12 ottone	3217 0278														
	15 ottone	3217 0286														
<b>Sandblasting lance kit • Kit lancia sabbiate</b>																
		3301 0801	*	*												
	ø 1,4	3301 0772			*	*	*	*	*	*	*	*	*	*	*	*
	055	3301 0864														
	ø 1,8	3301 0972														
	040 500 bar	3301 1219														
	050 500 bar	3301 1227														
	080 500 bar	3301 1228														
	090 500 bar	3301 0865														
<b>Sandblasting lance kit, with ball quick coupler + rubber suction hose + 15° nozzle • Kit lancia sabbiate, con attacco rapido a sfere + tubo</b>																
	15° - 040	3301 1333														
	15° - 050	3301 1334														
	15° - 080	3301 1335														
	15° - 090	3301 1336														
<b>Rotating brush • Idrospazzola rotante</b>																
	8÷ 11 l/min	1413 0029			*	*	*	*	*	*	*	*	*	*	*	*
	13÷ 18 l/min	1413 0030			*	*	*	*	*	*	*	*	*	*	*	*
		1413 0032	*	*												
		1413 0033	*	*												
<b>Kit foam lance kit • Kit lancia schiumogena</b>																
		3301 0795	●													
		3301 0901		*	*	*	*	*	*	*	*	*	*	*	*	*
<b>Drain cleaning kit • Kit sonda spurgatubi</b>																
	6÷ 9 l/min	3045 0034														
	16÷ 21 l/min	3045 0036									*	*				
	10÷ 15 l/min	3045 0041	*	*	*	*	*	*	*	*	*	*	*	*	*	*
	22÷ 33 l/min	3045 0044														
	10÷ 15 l/min	3045 0050														
	16÷ 29 l/min	3045 0051														
	30÷ 42 l/min	3045 0052														
<b>Rubber delivery hose kit • Kit tubo gomma mandata</b>																
	m 8 R1-1/4"	3208 1012		●	●	●	●									
	m 8 R1-1/4"	3208 1015	●													
	m 10 R2-3/8"	3301 0944														
	m 10 R2-5/16"	3301 0776										●	●			
	m 10 R1-5/16"	3301 0987						●	●	●	●	●		●	●	●
	m 10 R2-3/8"	3301 0658														
<b>Rubber delivery hose kit with quick coupling M24x1,5 • Kit tubo gomma mandata con innesti rapidi M24x1,5</b>																
	m 20 R2-3/8" 600 bar	3301 1226														
	m 20 R2-3/8" 400 bar	3301 1270														
	m 20 R2-1/2" 310 bar	3301 1268														



**FDX 2**
**Accessories • Accessori**
**Rubber delivery hose extension kit • Kit prolunga tubo gomma mandata**

			Axial Pumps Pompe Assiali						Triplex						Axial Pumps Pompe Assiali		
			10/150	12/200	11/150	13/150	12/170	14/200	12/140	13/180	14/190	16/210	16/250	15/270	11/150	13/150	12/170
	m 8 R1-1/4"	3301 0769		*					*	*							
	m 10 R1-5/16"	3301 0774			*	*	*	*			*	*			*	*	*
	m 8 R1-1/4"	3301 0811	*														
	m 10 R2-3/8"	3301 0946															
	m 10 R2-5/16"	3301 0985											*	*			
	m 20 R2-3/8" 600 bar	3301 1255															
	m 20 R2-3/8" 400 bar	3301 1271															
	m 20 R2-1/2" 310 bar	3301 1269															

**Hose reels • Avvolgitubi**

	m 20 R1-1/4"	7002 0236		*	*	*	*	*	*	*							
	m 15 R2-5/16"	7002 0237			*	*	*	*			*	*	*	*			
	m 15 R2-5/16"	7002 0245															
	m 15 R2-3/8"	7002 0246															
	m 15 R2-3/8"	7002 0333															
	m 15 R1-5/16"	7002 0315													*	*	*
	m 15 R2-5/16"	7002 0316															
	m 15 R2-5/16"	7002 0322															
	m 15 R1-1/4"	7002 0365															
	m 20 R2-3/8" 600 bar	7002 0336															
	m 20 R2-1/2" 310 bar	7002 0342															

**Back-flow preventer kit BA 10 • Kit disconnettore idrico BA 10**

	G3/4M G3/4M	0608 0049	*	*	*	*	*	*	*	*	*	*	*	*	*	*	*
	G3/4F G3/4F	5002 0024	*	*	*	*	*	*	*	*	*	*	*	*	*	*	*

**Quick water intake connection kit • Kit attacco rapido aspirazione acqua**













		5002 0021	*	*													
--	--	-----------	---	---	--	--	--	--	--	--	--	--	--	--	--	--	--

**Suction rubber hose kit with quickfit kit • Kit tubo gomma aspirazione con kit attacco rapido**

		3208 0783	*	*													
--	--	-----------	---	---	--	--	--	--	--	--	--	--	--	--	--	--	--

FDX Elite							FDX Pro					FDX 4						FDX XTREME					FDX HOT CUBE				FDX WB			PTO				
Triplex							15/270	15/300	16/200	16/250	18/220	15/150	16/200 FW2 Yanmar	21/160 FW2 Yanmar	16/200 FW2 Honda	16/250 RW Honda	18/220 RW Honda	21/200 RW Honda	15/500	18/400	21/350	30/280	36/230	42/200	16/200 D	16/200 B	21/160 D	21/160 B	8/160 LWD-K	8/160 BWD-K	15/150	21/200	23/200	30/170
14/200	12/140	13/180	14/190	16/210	16/250	15/270																												
*	*	*	*				*	*	*		*																	*	*					
															*			*	*						*	*				*	*	*	*	
				*	*	*				*	*		*	*											*	*								
																	*	*																
																			*	*														
													*	*	*																			
*	*	*	*										*			*	*																	
				*	*	*									*	*									*	*								
							●	●	●	●	●	●																						
																				*	*	*	*											
																				*	*													
*	*	*	*	*	*	*	*	*	*	*	*	*	*	*	*	*												*	*					
*	*	*	*	*	*	*	*	*	*	*	*	*	*	*	*	*												*	*					

**FDX 2**
**Accessories • Accessori**

			Axial Pumps Pompe Assiali						Triplex						Axial Pump Pompe Assi		
			10/150	12/200	11/150	13/150	12/170	14/200	12/140	13/180	14/190	16/210	16/250	15/270	11/150	13/150	12/170
<b>Thermostatic valve • Valvola termostatica</b>																	
	G 3/8M	1215 0354		*	*	*	*	*							●	●	●
	G 1/2M	1215 0355							*	*	*	*	*	*			
	G 1/2M	1215 0388															
<b>Spiral suction hose kit • Kit tubo aspirazione spiralato</b>																	
	m 8	3299 0019			*	*	*	*	*	*	*	*	*	*	*	*	*
<b>Injector kit • Kit eiettore</b>																	
	ø 2,7	3410 0333															
<b>Water suction filter • Filtro aspirazione acqua</b>																	
		1002 0159															
	50 mesh 70 l/min	1002 0238															
	cartuccia cartridge 50 mesh	1002 0239															
<b>Engine rev decelerator kit • Kit deceleratore giri motore</b>																	
		0608 0069															
<b>Flame control kit • Kit comando controllo fiamma</b>																	
		5018 0081															
<b>Suction strainer kit • Kit cestina di fondo</b>																	
	ø 25 mm	0401 0038															
<b>PTO frame kit • Kit telaio PTO</b>																	
		3206 0295															
<b>Foot pedal valve • Valvola pedale</b>																	
	G 3/8"	0608 0071															
<b>Protective clothing kit • Kit abbigliamento protettivo</b>																	
		0608 0070															



FDX Elite								FDX Pro						FDX 4						FDX XTREME						FDX HOT CUBE				FDX WB		PTO					
		Triplex						15/270	15/300	16/200	16/250	18/220	15/150	16/200 FW2 Yanmar	21/160 FW2 Yanmar	16/200 FW2 Honda	16/250 RW Honda	18/220 RW Honda	21/200 RW Honda	15/500	18/400	21/350	30/280	36/230	42/200	16/200 D	16/200 B	21/160 D	21/160 B	8/160 LWD-K	8/160 BWD-K	15/150	21/200	23/200	30/170		
●							●	●	●	●	●	●																	●	●							
	●	●	●	●	●	●	*	*	*	*	*	*	*		*	*	*	*	*																		
*	*	*	*	*	*	*	*	*	*	*	*	*	*		*	*	*	*							*	*	*	*									
																									*	*	*	*									
							●	●	●	●	●	●	●		●	●	●	●							●	●	●	●						●	●	●	●
							●	●	●	●	●				●	●	●	●							●		●										
																									●	●	●	●									
																																		*	*	*	*
																																	*	*	*	*	
																				*	*	*	*	*	*												
																				*	*	*	*	*	*												









			TRAPPER 2		SCOUT				KD2	KM BASIC	
Accessories • Accessori			120	GOLD 130 G	CLASSIC 150 C	EXTRA 150 E	CLASSIC 135 C	EXTRA 135 E	300	3.10	5.12
<b>Gun kit with guard • Kit pistola con protezione</b>											
	Gun • Pistola		2410 0096	●	●	●	●	●	●		
	MV2006 + pressure regulation MV2006 + reg.pressione		2410 0159			*	*	*	*		
			2410 0165							*	*
	GC 251		2410 0169						●	●	●
<b>Bent lance hose kit without nozzle • Kit tubo lancia angolata senza ugello</b>											
		mm 700	3301 0787			●	●	●	●		
		mm 500	3301 0935						●	●	●
		mm 500	3301 1143	●	●						
<b>Lance with adjustable jet kit • Kit tubo lancia getto regolabile</b>											
		ø 1,3	3301 0907								*
		ø 1,4	3301 0909								*
		ø 1,2	3301 0927				*	*			
		ø 1,3	3301 1016						*		
		ø 1,1	3301 1054			*	*				
<b>Lance with rotating nozzle kit • Kit tubo lancia con ugello rotante</b>											
		04	3301 0777					*	*	*	*
		035	3301 0780	*	*	*	*				
		035	3301 0781								*
<b>Double barrel lance kit • Kit tubo lancia canna doppia</b>											
		mm 700	3301 0941	*	*	*	*	*	*	*	*
	+det. nozzle + ugello det.	ø 4	3400 0391	*	*	*	*	*	*	*	*
<b>Fan shape nozzle 15° attacco 1/4" MEG • Ugello con getto a lama 15° attacco 1/4" MEG</b>											
		ø 1,09 15 03	3400 0400			●	●				
		ø 1,14 15 035	3400 0402						●	●	
		ø 1,19 15 04	3400 0397					●	●		●
		25° ø 1,0 15 025	3400 0546	●	●						
<b>Sandblasting lance kit • Kit lancia sabbiante</b>											
		ø 1,2	3301 0771						*	*	
		ø 1,4	3301 0772								*
		ø 1,2	3301 0989	*	*	*	*	*	*	*	
<b>Foam lance kit • Kit lancia shiumogena</b>											
			3301 0766			*	*	*	*	*	*
			3301 0795	●	●						
<b>Rotating brush max 60° • Idrospazzola rotante max 60°</b>											
		8÷ 11 l/min	1413 0029							*	*
		13÷ 18 l/min	1413 0033	*	*	*	*	*	*	*	*

			TRAPPER 2		SCOUT				KD2	KM BASIC	
Accessories • Accessori			120	GOLD 130 G	CLASSIC 150 C	EXTRA 150 E	CLASSIC 135 C	EXTRA 135 E	300	3.10	5.12
<b>Drain cleaning kit • Kit sonda spurgatubi</b>											
	m 8 6 ÷ 9 l/min	3045 0028	*	*	*	*					
	m 15 6 ÷ 9 l/min	3045 0029	*	*	*	*			*		
	m 25 10 ÷ 15 l/min	3045 0041					*	*	*	*	*
<b>Rubber delivery hose kit SAE 100 • Kit tubo gomma mandata SAE 100</b>											
	m 8 R1-1/4"	3208 1015	●	●	●		●				
	m 10 R1-1/4"	3208 1016				●		●			
	m 10 R1-1/4"	3208 1050							●	●	
	m 10 R1-5/16"	3301 0987									●
<b>Rubber delivery hose extension kit SAE 100 • Kit prolunga tubo gomma mandata SAE 100</b>											
	m 8 R1-1/4"	3301 0769							*	*	
	m 10 R1-5/16"	3301 0774			*		*				*
	m 8 R1-1/4"	3301 0811	*	*		*		*			
<b>Kit tubo aspirazione spiralato • Spiral suction hose kit</b>											
	m 8	3299 0019	*	*	*	*	*	*	*	*	*
<b>Hose reel with rubber hose • Avvolgitubo girevole con tubo gomma</b>											
	m 15 R1-5/16"	7002 0270							*		
	m 15 R1-5/16"	7002 0369								*	*
<b>Back-flow preventer kit BA 10 • Kit disconnettore idrico BA 10</b>											
	G3/4M G3/4M	0608 0049	*	*	*	*	*	*	*	*	*
	G3/4F G3/4F	5002 0024	*	*	*	*	*	*	*	*	*
<b>Anti-scale device • Dispositivo anticalcare</b>											
		0608 0047	*	*	*	*	*	*	*	*	*
<b>Water suction filter • Filtro aspirazione acqua</b>											
		1002 0129			*	*	*	*			
<b>Exhausted fumes conveyor • Convogliatore di fumi esausti camino</b>											
		0466 0055							*	*	*

Accessories • Accessori			KM CLASSIC								KM EXTRA					
			3.11	5.13	5.15	8.15	with Water tray and Anti-scale tank con Vasch. acqua e Anticalcare				3.11	5.13	5.15	8.15		
<b>Gun kit with guard • Kit pistola con protezione</b>																
	GH 351 + Swivel (n. 2 o-ring)	2410 0114											•	•	•	•
	GH 351 + revolving lance + det. head GH 351 + lancia girevole + testa det.	2410 0124	*	*	*	*	*	*	*	*	*					
	GH 351 + fixed lance + det. head GH 351 + lancia fissa + testa det.	2410 0126	*	*	*	*	*	*	*	*	*					
	GH 351 + fixed lance + nozzle holder head GH 351 + lancia fissa + testa portaugello	2410 0128											*	*	*	*
	GH 351 + swivel lance+nozzle holder head GH 351 + lancia girevole + testa portaugello	2410 0130											*	*	*	*
	GH 301 with Swivel GH 301 con Swivel	2410 0182	•	•	•	•	•	•	•	•	•					
<b>Bent lance hose kit without nozzle • Kit tubo lancia angolata senza ugello</b>																
	mm 700	3301 0787	•	•	•	•	•	•	•	•	•					
	mm 700	3301 0974											•	•	•	•
	mm 700	3301 0976														
<b>Bent lance, with nozzle holder (without nozzle) • Lancia angolata, testa portaugello(senza ugello)</b>																
	mm 700	3301 1354							•	•	•	•				
<b>Lance with adjustable jet kit • Kit tubo lancia getto regolabile</b>																
	ø 1,5	3301 0911		*						*			*	*		*
	ø 1,55	3301 0913	*				*	*			*					
	ø 1,62	3301 0915												*		
	ø 1,8	3301 1085														
	ø 1,65	3301 1094			*						*					
<b>Lance hose kit with rotating nozzle • Kit tubo lancia con ugello rotante</b>																
	045	3301 0782		*						*			*	*		*
	05	3301 0893	*			*	*	*			*					
	055	3301 0895												*		
	06	3301 0897			*						*					
	07	3301 0899														
<b>Double barrel lance kit • Kit tubo lancia canna doppia</b>																
	mm 700	3301 0941	*	*	*	*	*	*	*	*	*	*	*	*	*	*
	ø 4	3400 0391	*	*	*	*	*	*	*	*	*	*	*	*	*	*
<b>Fan shape nozzle 25°, 1/4" MEG connection • Ugello con getto a lama 25°, attacco 1/4" MEG</b>																
	25 045	3400 0419		•						•			•	•		•
	25 050	3400 0422	•			•	•	•			•					
	25 055	3400 0423													•	
	25 060	3400 0421			•						•					
	25 070	3400 0519														
	25 070	3400 0541														

KE PREMIUM PLUS 15/200			KF CLASSIC without a water tray senza vaschetta acqua				KF CLASSIC with a water tray con vaschetta acqua								KF EXTRA							
STD	Water tray vasch. acqua	Anti-scale tank Anticalcare	3.11	5.15	6.15	8.15	3.11	5.15	6.15	8.15	9.18	9.21	10.18	10.21	3.11	6.15	8.15	9.18	9.21	10.18	10.21	
●	●	●	●	●	●	●	●	●	●	●	●	●	●	●	●	●	●	●	●	●	●	●
*			*	*	*	*																
*			*	*	*	*																
	*	*					*	*	*	*	*	*	*	*	*	*	*	*	*	*	*	*
	*	*					*	*	*	*	*	*	*	*	*	*	*	*	*	*	*	*
	●	●					●	●	●	●	●	●	●	●	●	●	●	●	●	●	●	●
●			●	●	●	●																
							*								*							
	*	*	*						*							*						
*						*		*	*				*			*				*		*
											*		*					*			*	*
				*	*						*						*					
	*	*	*			*		*	*				*			*				*		*
				*	*						*						*				*	*
							*								*						*	*
*	*	*	*	*	*	*	*	*	*	*	*	*	*	*	*	*	*	*	*	*	*	*
*	*	*	*	*	*	*	*	*	*	*	*	*	*	*	*	*	*	*	*	*	*	*
●	●	●	●				●			●					●		●				●	
				●	●			●	●		●			●		●		●			●	
											●							●				●
												●		●					●			●







**RED SERIES PROFESSIONAL**

Accessories • Accessori			KM CLASSIC								KM EXTRA						
			3.11	5.13	5.15	8.15	with Water tray and Anti-scale tank con Vasch. acqua e Anticalcare				3.11	5.13	5.15	8.15			
<b>Sandblasting lance kit • Kit lanca sabbiante</b>																	
	ø 1,4	3301 0772	*	*		*	*	*		*	*		*	*		*	
	ø 1,8	3301 0972			*						*			*			
<b>Foam lance kit with regulator • Kit lancia schiumogena con regolatore</b>																	
		3301 0901	*	*	*	*	*	*	*	*	*	*	*	*	*	*	
<b>Rotating brush max 60° • Idrospazzola rotante max 60°</b>																	
	8÷ 11 l/min	1413 0029	*					*				*					
	13÷ 18 l/min	1413 0030		*	*	*			*	*	*		*	*	*	*	
<b>Drain cleaning kit, 25 m • Kit sonda spurgatubi m 25</b>																	
	15÷ 21 l/min	3045 0036															
	10÷ 15 l/min	3045 0041	*	*	*	*	*	*	*	*	*	*	*	*	*	*	
<b>Rubber delivery hose kit SAE 100 • Kit tubo gomma mandata SAE 100</b>																	
	m 10 R1-1/4"	3208 1050	●					●				●					
	m 10 R2-5/16"	3301 0776				●				●						●	
	m 10 R2-3/8"	3301 0944															
	m 10 R1-5/16"	3301 0987		●	●				●	●			●	●			
<b>Rubber delivery hose extension kit SAE 100 • Kit prolunga tubo gomma mandata SAE 100</b>																	
	m 8 R1-1/4"	3301 0796	*					*				*					
	m 10 R1-5/16"	3301 0774		*	*				*	*			*	*			
	m 10 R2-3/8"	3301 0946															
	m 10 R2-5/16"	3301 0985				*					*					*	
	m 15 R2-5/16"	3301 0991															
<b>Spiral suction hose kit • Kit tubo aspirazione spiralato</b>																	
	m 8	3299 0019	*	*	*	*	*	*	*	*	*	*	*	*	*	*	
<b>Hose reel with rubber hose • Avvolgitubo girevole con tubo gomma</b>																	
	m 15 R2-5/16"	7002 0238															
	m 15 R2-3/8"	7002 0246															
	m 15 R1-5/16"	7002 0270															
	m 15 R1-5/16"	7002 0369	*	*	*			*	*	*		*	*	*	*	*	
	m 15 R2-5/16"	7002 0370	*	*	*	*	*	*	*	*	*	*	*	*	*	*	
<b>Steam nozzle kit with curved lance • Kit ugello vapore con lancia curva</b>																	
	mm 700	3301 1100										*	*	*	*		

● Standard accessories • Dotazione standard \* Accessories • Accessori

KE PREMIUM PLUS 15/200			KF CLASSIC without a water tray senza vaschetta acqua				KF CLASSIC with a water tray con vaschetta acqua							KF EXTRA							
STD	Water tray vasch. acqua	Anti-scale tank Anticalcare	3.11	5.15	6.15	8.15	3.11	5.15	6.15	8.15	9.18	9.21	10.18	10.21	3.11	6.15	8.15	9.18	9.21	10.18	10.21
*	*	*	*			*	*	*	*	*			*		*	*	*			*	
				*	*						*	*		*				*	*		*
*	*	*	*	*	*	*	*	*	*	*	*	*	*	*	*	*	*	*	*	*	*
			*				*								*						
*	*	*		*	*	*		*	*	*	*		*			*	*	*		*	
*	*	*									*	*	*	*				*	*	*	*
			*	*	*	*	*	*	*	*					*	*	*				
●	●	●				●				●							●				
											●	●	●	●				●	●	●	●
			●	●	●		●	●	●						●	●					
			*	*	*		*	*	*						*	*					
											*	*	*	*				*	*	*	*
*	*	*				*			*								*				
*	*	*																			
*	*	*	*	*	*	*	*	*	*	*	*	*	*	*	*	*	*	*	*	*	*
*	*	*				*			*								*				
										*	*	*	*					*	*	*	*
			*	*	*		*	*	*						*	*					
															*	*	*	*	*	*	*

**RED SERIES PROFESSIONAL**

			KM CLASSIC								KM EXTRA			
			3.11	5.13	5.15	8.15	with Water tray and Anti-scale tank con Vasch. acqua e Anticalcare				3.11	5.13	5.15	8.15
Accessories • Accessori			3.11	5.13	5.15	8.15	3.11	5.13	5.15	8.15	3.11	5.13	5.15	8.15
<b>Exhausted fumes conveyor • Convogliatore di fumi esausti camino</b>														
		0466 0055	*	*	*	*	*	*	*	*	*	*	*	*
<b>Kit disconnettore idrico BA 10 • Back-flow preventer kit BA 10</b>														
	G3/4M G3/4M	0608 0049	*	*	*	*	*	*	*	*				
	<b>Kit raccordi attacco rapido 3/4</b> Garden hose quick couplers	G3/4F G3/4F	5002 0024	*	*	*	*	*	*	*				
<b>Dispositivo anticalcare • Anti-scale device</b>														
		0608 0047	*	*	*	*	*	*	*	*				
<b>Kit elettrovalvola detergente • Detergent solenoid valve kit</b>														
	24 V	0802 0015												
<b>Kit comando controllo fiamma • Flame control kit</b>														
		5018 0081									●	●	●	●
<b>Kit serbatoio anticalcare • Anti-scale tank kit</b>														
		5018 0092												



KE PREMIUM PLUS 15/200			KF CLASSIC without a water tray senza vaschetta acqua				KF CLASSIC with a water tray con vaschetta acqua							KF EXTRA								
STD	Water tray vasch. acqua	Anti-scale tank Anticalcare	3.11	5.15	6.15	8.15	3.11	5.15	6.15	8.15	9.18	9.21	10.18	10.21	3.11	6.15	8.15	9.18	9.21	10.18	10.21	
*	*	*	*	*	*	*	*	*	*	*	*	*	*	*	*	*	*	*	*	*	*	*
*	*	*	*	*	*	*																
*	*	*	*	*	*	*																
*	*	*	*	*	*	*																
* only models without water tray solo modelli senza cisterna			*	*	*	*																
									*	*	*	*	*	*	*	*	*	*	*	*	*	*
															*	*	*	*	*	*	*	*
									*	*	*	*	*	*								

# ACCESSORIES - ACCESSORI

Modello Model	Codice Code	Tubo flessibile Flexible hose			Prolunga / Extension tube			Bocchetta / Attachment	
		bocchetta attachment	manicotti couplings	elettrot. power-driven	dritta plastica straight plastic	curva acciaio cromato superiore bent chrome-plated steel upper	curva acciaio cromato inferiore bent chrome-plated steel lower	lancia lance	impugn. ergonomica con deflussore ergonomic handle and tube
AC 18 ASPIRACENERE	9350 0038	3208 1131							
AS 21 INOX	9350 0034		3208 1128		2417 0063			0219 0003	
AS 21	9350 0036		3208 1128		2417 0063			0219 0003	
AS 31 INOX	9350 0035		3208 1128		2417 0063			0219 0003	
AS 31	9350 0037		3208 1128		2417 0063			0219 0003	
AS 22	9350 0003		3208 0964		2417 0063			0219 0003	1411 0030
AS 35 PRO	9350 0004		3208 0966		2417 0062			0219 0001	
AS 25 PRO-E	9350 0010		3208 0980		2417 0063			0219 0003	
AS 50 PRO-E	9350 0006		3208 1134	3208 0968		3208 0969	3208 0988	0219 0001	
AS 50 AS 50 PRO-B	9350 0005		3208 1134			3208 0969	3208 0988	0219 0001	
	9350 0008								

Modello Model	Codice Code	Tubo flessibile / Flexible hose						Prolunga / Extension tube					lancia lance
		manicotti couplings	senza manicotti without couplings	elettrot. power- driven	idrolitico hydrolytic	antistatico antistatic	raccogli liquidi liquid vacuuming	dritta plastica straight plastic	curva acciaio cromato superiore bent chrome- plated steel upper	curva acciaio cromato inferiore bent chrome- plated steel lower	curva acciaio cromato bent chrome- plated steel	dritte acciaio cromato straight chrome- plated steel	
AS 70 AS 70 PRO-B	9350 0007 9350 0009												
AS 70	9350 0007								3208 0969	3208 0988			0219 0001
AS 70 PRO-B	9350 0009	3208 1134											
AS 37 VIBRA	9350 0032		3208 1045	3208 1048							3208 1047	3208 1046	0219 0006
AS 80 BI POWER	9350 0011	3208 0986				3208 0985	2417 0062	3208 0969	3208 0988				0219 0018
AS 75 F2	9350 0025		3208 1045								3208 1047	3208 1046	0219 0006
AS 77 B2	9350 0026		3208 1045								3208 1047	3208 1046	0219 0006
AS 78 B3	9350 0027		3208 1045								3208 1047	3208 1046	0219 0006
ASL 76 LANCIA LAVAP.	9350 0029	3208 1045			3208 1049						3208 1047	3208 1046	0219 0006
ASL 81-B3 METALOIL	9350 0033		3208 1112			3208 1111					3208 1113		0219 0012 0219 0014 0219 0015 0219 0016

Bocchetta / Attachment		Spazzola pennello <i>Brush attachment</i>	Telaio per spazzola combin. <i>Support for combi-brush</i>	Racla			Spazzola / Brush				
per detriti <i>for dirt-intake</i>	per imbottiti <i>for soft furnishings</i>			moquette <i>carpet</i>	liquidi <i>liquids</i>	polveri <i>dust</i>	moquette <i>carpet</i>	liquidi <i>liquids</i>	polveri <i>dust</i>	pulisci griglia <i>grill cleaner</i>	
										3046 0036	
			3206 0277	3046 0024	3046 0022						
			3206 0277	3046 0024	3046 0022						
			3206 0277	3046 0024	3046 0022						
			3206 0277	3046 0024	3046 0022						
0219 0002	0219 0004	3046 0018	3206 0277	3046 0024	3046 0022	3046 0023					
			3206 0275	3046 0019	3046 0021	3046 0020					
	0219 0004		3206 0277		3046 0022	3046 0023					
0219 0002									3046 0016	3046 0017	3046 0015
0219 0002		3046 0014							3046 0016	3046 0017	3046 0015

Bocchetta / Attachment					Spazzola pennello <i>Brush attachment</i>	Telaio per spazzola combin. <i>Support for combi-brush</i>	Racla			Spazzola / Brush			Supporto cestello <i>Basket</i>	
lava moquette <i>carpet cleaning</i>	lava poltrone <i>couch cleaning</i>	per detriti <i>for dirt-intake</i>	raccogli liquidi <i>liquid vacuuming</i>	ventosa ondulata <i>corrugated squeegee</i>			moquette <i>carpet</i>	liquidi <i>liquids</i>	polveri <i>dust</i>	moquette <i>carpet</i>	liquidi <i>liquids</i>	polveri <i>dust</i>	porta accessori <i>accessories storage</i>	inferiore porta accessori <i>lower accessories storage</i>
		0219 0002			3046 0014					3046 0016	3046 0017	3046 0015		
					3046 0027	3206 0318	3046 0032		3046 0031					
		0219 0019	0219 0005							3046 0016	3046 0017	3046 0015		
					3046 0027					3046 0030	3046 0029	3046 0028		
					3046 0027					3046 0030	3046 0029	3046 0028	3002 0625	3002 0628
					3046 0027					3046 0030	3046 0029	3046 0028	3002 0625	3002 0628
0219 0007	0219 0008	0219 0017			3046 0027					3046 0030	3046 0029	3046 0028		3002 0628
				0219 0013	3046 0035	3206 0319		3046 0034	3046 0033				3002 0625	

## Ugelli Acqua Water Nozzles



MODEL MODELLO	JET ANGLE ANGOLO GETTO	F.M. (TECSI)	SPRAY SYSTEMS	MODEL MODELLO	JET ANGLE ANGOLO GETTO	F.M. (TECSI)	SPRAY SYSTEMS
		CODE CODICE	CODE CODICE			CODE CODICE	CODE CODICE
025	0°	-	-	075	0°	<b>3400 0411</b>	-
	15°	<b>3400 0546</b>	-		15°	<b>3400 0412</b>	-
	25°	<b>3400 0629</b>	-		25°	<b>3400 0413</b>	<b>3400 0425</b>
	40°	-	-		40°	<b>3400 0414</b>	-
030	0°	<b>3400 0404</b>	-	080	0°	-	-
	15°	<b>3400 0400</b>	-		15°	-	-
	25°	<b>3400 0387</b>	<b>3400 0606</b>		25°	<b>3400 0521</b>	<b>3400 0491</b>
	40°	<b>3400 0401</b>	-		40°	-	-
035	0°	<b>3400 0398</b>	-	085	0°	<b>3400 0395</b>	-
	15°	<b>3400 0402</b>	-		15°	<b>3400 0405</b>	-
	25°	<b>3400 0379</b>	<b>3400 0596</b>		25°	<b>3400 0406</b>	-
	40°	<b>3400 0382</b>	-		40°	<b>3400 0407</b>	-
040	0°	<b>3400 0396</b>	-	090	0°	<b>3400 0635</b>	-
	15°	<b>3400 0397</b>	-		15°	<b>3400 0636</b>	-
	25°	<b>3400 0388</b>	<b>3400 0420</b>		25°	<b>3400 0637</b>	-
	40°	<b>3400 0399</b>	-		40°	<b>3400 0638</b>	-
045	0°	<b>3400 0380</b>	-	095	0°	<b>3400 0641</b>	-
	15°	<b>3400 0392</b>	-		15°	-	-
	25°	<b>3400 0386</b>	<b>3400 0419</b>		25°	-	-
	40°	<b>3400 0393</b>	-		40°	-	-
050	0°	<b>3400 0384</b>	-	10	0°	-	-
	15°	<b>3400 0389</b>	-		15°	-	-
	25°	<b>3400 0375</b>	<b>3400 0422</b>		25°	<b>3400 0523</b>	<b>3400 0488</b>
	40°	<b>3400 0390</b>	-		40°	-	-
055	0°	<b>3400 0381</b>	-	11	0°	-	-
	15°	<b>3400 0408</b>	-		15°	-	-
	25°	<b>3400 0376</b>	<b>3400 0423</b>		25°	<b>3400 0543</b>	-
	40°	<b>3400 0378</b>	-		40°	-	-
060	0°	<b>3400 0630</b>	-	12	0°	-	-
	15°	<b>3400 0631</b>	-		15°	-	-
	25°	<b>3400 0632</b>	<b>3400 0421</b>		25°	<b>3400 0639</b>	-
	40°	-	-		40°	-	-
065	0°	<b>3400 0383</b>	-	13	0°	-	-
	15°	<b>3400 0385</b>	-		15°	-	-
	25°	<b>3400 0377</b>	<b>3400 0424</b>		25°	<b>3400 0640</b>	<b>3400 0489</b>
	40°	<b>3400 0394</b>	-		40°	-	-
070	0°	<b>3400 0633</b>	-	15	0°	-	-
	15°	<b>3400 0634</b>	-		15°	-	-
	25°	<b>3400 0541</b>	<b>3400 0519</b>		25°	<b>3400 0658</b>	<b>3400 0489</b>
	40°	-	-		40°	-	-

MODEL MODELLO	JET ANGLE ANGOLO GETTO	MECLINE (Inserto Ceramico)	MAX PRESSURE PRESSIONE MAX	
		CODE CODICE	bar	p.s.i.
025	0°	-	<b>500</b>	<b>7250</b>
	15°	<b>3400 0627</b>		
030	0°	<b>3400 0619</b>	<b>500</b>	<b>7250</b>
	15°	<b>3400 0614</b>		
035	0°	<b>3400 0621</b>	<b>500</b>	<b>7250</b>
	15°	<b>3400 0615</b>		
040	0°	<b>3400 0620</b>	<b>500</b>	<b>7250</b>
	15°	<b>3400 0616</b>		
050	0°	<b>3400 0622</b>	350	5075
	25°	<b>3400 0618</b>		
075	0°	<b>3400 0623</b>	350	5075
	25°	<b>3400 0617</b>		
080	0°	<b>3400 0625</b>	350	5075
	25°	<b>3400 0612</b>		
11	0°	<b>3400 0624</b>	350	5075
	25°	<b>3400 0613</b>		
15	0°	<b>3400 0626</b>	350	5075
	25°	<b>3400 0611</b>		







[www.comet-spa.com](http://www.comet-spa.com)



Comet Spa › Reggio Emilia › Italy  
phone + 39 0522 386111 › [www.comet-spa.com](http://www.comet-spa.com)  
Italia: [vendite@comet.re.it](mailto:vendite@comet.re.it) › Fax + 39 0522 386300  
Export: [export@comet.re.it](mailto:export@comet.re.it) › Fax + 39 0522 386280